



TEACH • LEARN • GROW



 **Fleetwood**[®]
Creating effective learning environments™

Tables & Desks | Storage | Seating | Accessories

TEACH ▪ LEARN ▪ GROW

These three words are the essence of education. It sounds simple, but we know it's not. We're part of a complex recipe, blending talented people, sound strategies and inspiring, agile spaces. Our role is to create effective environments that help prepare young people for college, career and life. Teach. Learn. Grow. Let's get cooking.



We are Fleetwood...

...A company that's big enough to furnish an entire school (or K-12 system) anywhere in the U.S., yet small enough to give every order our full attention.

...A company that recognized the need for greater mobility in the classroom more than 65 years ago... and continues to infuse our product and application design with insights from our research about how space impacts activity, connection and engagement.

...A company that is 100% owned by its employees, so every member of the Fleetwood family has a personal stake in helping students learn and in satisfying our customers.

...A company that gives back, by dedicating 20 percent of its profits to mission work around the world and providing paid time-off for employees to pursue their own passions for community service.



> In every **interaction**, we strive to be **S-A-F-E**:

Designs driven by research

Our vision is to help students learn. It's another one of those simple ideas with a lot of thoughtful design behind it. Our research-inspired furniture and applications increase student and teacher engagement, connection and well-being. Our commitment to operations excellence means our products will arrive when we say they will (we hit 99 percent of our confirmed delivery dates) and last a lifetime.



Check out our products, applications and research at fleetwoodfurniture.com or scan the QR code.



SMART

Our products and applications solve today's classroom challenges and anticipate tomorrow's.

AUTHENTIC

We keep our promises, build respectful relationships and communicate fully.

FRESH

Clean aesthetics and human-centered design go into our newest solutions for learning and well-being.

EASY

Our personalized customer service is backed by a best-in-class warranty, and we can offer the warranty with confidence because of the quality and durability of our products.



What inspires us?

Sure, we're very proud of our products. We're even more proud of what our products DO: They meet the needs of the people who use, spec, clean and pay for our products.

Our process starts with listening to those people and observing what takes place in the classroom. In partnership with leading academic researchers, we gathered more than 500 hours of video in the two years prior to the pandemic. Those observations, combined with our interviews and secondary research, led to insights – those “aha moments” that help reduce pain points and workarounds and support activity, connection and engagement.



Space Activated Learning

Our research identified four key elements that contribute to student engagement. Just as a dash of lemon juice brings out the other flavors in a recipe, an agile space unleashes the power of the other components. It allows teachers to teach the way they want to teach, improves student focus and brings together analog and digital information in ways that lead to success.

TEACHING METHODS



Insights:

- Allow teachers to modify space based on personal style and subject matter
- Plan for project-based learning all over the room
- Support changes in teaching methods during and between classes
- Create space for circulation to improve student/teacher interaction

STUDENT BEHAVIORS



Insights:

- Create more “alert” postures that activate the core
- Promote movement and posture changes with multiple seating choices
- Support fidgeting without judgment
- Allow students to naturally turn to multiple focal points



SPACE

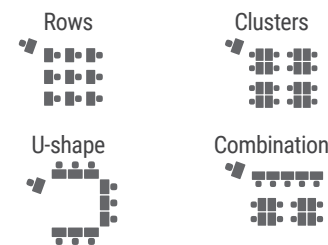

Insights:

- Reduce risk and long-term cost with furniture designed to last
- Design with height-adjustability and mobility in mind
- Choose products with simple, non-handed shapes for maximum flexibility
- Integrate storage into the classroom footprint that performs multiple functions, including space division

INFO-MEDIUM

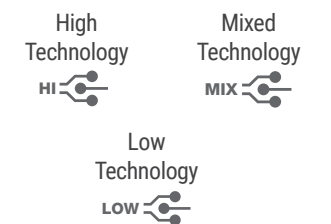

Insights:

- Equip rooms so students can blend analog, digital and interpersonal
- Balance projection and small group monitors to optimize learning
- Keep the lights up for engagement
- Plan for sightlines and power access



Built to last. Designed to adapt. Let Fleetwood inspire you.

Our story

Unless you skipped ahead to see the hot products and cool applications (and we would totally understand if you did), you've already read part of our story. But, we saved the best part – our people – for last.

- We are Fleetwood 3
- Designs driven by research 4
- What inspires us? 6
- Employees matter 146
- Giving back to the community 147

Changing with the times

A generation ago, this table of contents would have been shorter. No one was asking us for STEM rooms or makerspaces, after all. That's just one of the ways that K-12 education is changing, and Fleetwood is changing with it.

We're ready with insight-based applications for every space in your building except the custodian's closet. (And we could probably come up with something for that, if called upon.) We'll be ready to add to this list as education continues to evolve.

- Kindergarten to Second Grade 14
- Third to Fourth Grade 16
- Fifth to Sixth Grade 18
- Junior High/Middle School 20
- High School 22
- Makerspace 26
- Art 28
- Music 30
- Science 32
- STEM 34
- Career and Technical Education 36
- Computer Lab 38
- Library 40
- Media Center 42
- Commons 44
- Café/Life Center 46
- Teacher/Faculty Lounge 48
- Administration 50
- Environments that Keep Flexing 52

Our products

If you think you know Fleetwood, you might be surprised. In our product pages and at fleetwoodfurniture.com, you'll discover that we've bolstered our seating portfolio, introduced new storage choices, added new surface materials and much more.

If you're looking for something you don't see in this catalog, let's talk. We do our best to accommodate special requests. Or, ask about our Quick Ship program if there's an item you need in a hurry.

- TABLES & DESKS 54-83
- STORAGE 84-119
- SEATING 120-133
- ACCESSORIES 134-137
- FINISHES 138-145



Our Solutions



Tables & Desks

One of the industry's broadest offerings is also one of the easiest to specify, install and use across the school environment. Line-wide compatibility ensures visual and functional consistency while mobile and height-adjustable options maximize flexibility.

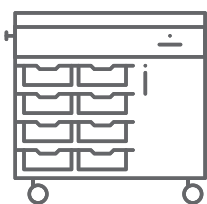

Storage

We offer just the right storage for every space and purpose, all boasting exceptional strength and durability for a lifetime of heavy-duty service. The comprehensive selection – including two newly enhanced collections – allows a custom fit without the custom upcharge.



Seating

Shell chairs, stools and soft seating are all designed to encourage healthy movement and boost student engagement.

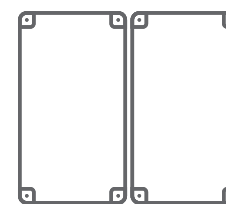

Accessories

Our dry erase markerboard system adds versatile presentation capabilities to any school space, on the wall or off.

It all works together

All Fleetwood furnishings coordinate seamlessly with each other, so you can confidently mix and match product lines, repurpose pieces from room to room and add new components whenever you need them.

We've got your entire campus. We've got you.

Why specify from multiple manufacturers when you can get everything you need from a single source? Furnish your entire campus with Fleetwood to avoid the time and expense of dealing with different vendors. You'll create a consistent look throughout your school and maintain a more agile environment – because you can be sure that all your furniture will work together, no matter how (and how many times) you rearrange, reconfigure and redesign your spaces.

Adding Fleetwood to your existing furniture inventory? No worries – our clean, timeless designs complement most any environment. Plus, we can match the colors and finishes of many other manufacturers to support your standards program.

The next few pages highlight some of the most common applications for our furniture. We'd be happy to work with you to devise tailored solutions for your spaces!



Kindergarten to Second Grade • page 14



Third to Fourth Grade • page 16



Fifth to Sixth Grade • page 18



Junior High/Middle School • page 20



High School • page 22



Makerspace • page 26



Art • page 28



Music • page 30



Science • page 32



STEM • page 34



Career & Technical Education • page 36



Computer Lab • page 38



Library • page 40



Media Center • page 42



Commons • page 44



Café/Life Center • page 46



Teacher/Faculty Lounge • page 48



Administration • page 50

APPLICATIONS

Kindergarten to Second Grade

TEACHING METHOD

- Demonstrate

STUDENT BEHAVIOR

- Group

SPACE

- Combination

INFO-MEDIUM

- Low technology

Big ideas for small folks.

Activate lower elementary spaces by allowing students to move easily from one color-coded station to the next. Our mobile tables permit reconfiguration when needed but lock securely in place to prevent disarray. Height-adjustable tables maximize future flexibility. Different seating options, scaled for smaller bodies, allow students to sit at tables, stand, lounge, kneel or plop down on the floor during the day.

Bright biophilic colors add energy and focus to the space, enriching the learning experience. Central storage accommodates personal items and learning materials, while tech-enabled storage supports teacher demonstrations.



What our research tells us

Ever watch a first-grade soccer team? All players on both sides are drawn to the ball and move around the field as a single blob. You can find “bunchball” in the classroom, too. Young elementary students need to move frequently to keep their focus and release excess energy. When they try to take their furniture with them, however, it’s chaos. Learning centers – from a reading corner to a counting display – present a set of unique ecosystems (and seating options) within a single classroom. The students move easily from station to station, but the furniture stays put.



APPLICATIONS

Third to Fourth Grade

TEACHING METHOD

- Personalize

STUDENT BEHAVIOR

- Group

SPACE

- Combination

INFO-MEDIUM

- Mixed technology

Growing up empowered.

Our research reveals that mid-level elementary classes need to incorporate additional flexibility. Students can move our mobile desks into different configurations to support project, individual, lecture, discussion and freeform activities. Different styles and levels of seating encourage healthy movement and posture change throughout the day.

Biophilic colors evoke nature to enhance learning, while bright whiteboards provide plenty of room for sharing ideas. Bookcases store materials and help divide space.



What our research tells us

We're big fans of design thinking, which puts the user at the center of our product development decisions, and we like to spread the word. We partnered with San Diego middle school students to introduce and apply design thinking techniques in the creation of a better presentation cart. The students identified user needs, built and tested prototypes and considered environmental impacts. You can see the video of this exercise on our website, and don't miss the students' joy as they see the final version.



APPLICATIONS
Fifth to Sixth Grade

TEACHING METHOD

- Facilitate

STUDENT BEHAVIOR

- Group

SPACE

- Combination

INFO-MEDIUM

- Mixed technology

More formal, still fun.

We support the evolution to a more structured learning environment with adjustable-height tables that can be easily configured (and reconfigured) in rows, clusters and u-shapes. Shell chairs provide a comfortable sit for longer stretches of instruction while still promoting healthy body movement and productive fidgeting. A wider variety of storage accommodates a broader range of teaching methods and materials.

Complementary tables and seating in varying heights provide ample opportunity for smaller group interactions and student-directed learning.



What our research tells us

Not all learning is teacher to student. Student to student learning takes place every day, and it's powerful. Students today are comfortable moving from analog to digital mediums and back again. It's another reason that flexible design is so crucial. Viewing someone else's laptop screen and brainstorming ideas being captured on a personal whiteboard require very different setting. We've seen that the most successful settings have planned for sight lines, light levels, storage adjacencies and power access.



APPLICATIONS

Junior High/Middle School

TEACHING METHOD

- Facilitate

STUDENT BEHAVIOR

- Group

SPACE

- Clusters

INFO-MEDIUM

- Mixed technology

The subject is flexibility.

A core group of adjustable-height tables can be utilized across multiple subjects and give you the flexibility to modify heights and configurations for unique teaching methods and student behaviors. Space-saving storage that integrates media displays or markerboards create more open floor space, while mobile storage supports spontaneous reconfiguration by teachers. Complementary seating and table options further personalize spaces and encourage movement.

Selecting furniture with built-in flexibility makes buying and life-cycle management simpler, easier and more affordable.



What our customers tell us

“Bringing nature into the classroom” used to mean having a turtle in a glass box on the science table. Today, at all levels of K-12 education, we’re seeing a rising trend toward bringing the outside in through natural materials, colors and displays. This type of biophilic design recognizes the value of connecting with nature – and it goes hand in hand with ergonomics, movement and other strategies for improving health and productivity for students and teachers.



APPLICATIONS
High School

TEACHING METHOD

- Facilitate

STUDENT BEHAVIORS

- Group
- Class

SPACE

- Combination

INFO-MEDIUM

- Low technology

A space for everything.

Start with a few minutes of lecture, then switch to hands-on project work at each table. Tables can be reconfigured to help larger groups collaborate in a makerspace. If the next hour's class is larger, quickly roll another table into position and flip the top into place, or move all tables into the corner to open up floorspace. Stools allow students to sit, stand, perch, rotate and fidget, boosting alertness and engagement.

Higher tables and stools promote better eye contact between students and teachers, which leads to increased engagement.



What our research tells us

It's not intentional, but all too often teachers get trapped. They find themselves in the corner of the classroom, hemmed in by a combination of furniture, audio/visual equipment and backpacks clogging every aisle. There's a significant decline in interaction and student engagement when teachers can't easily circulate through the room. One way to help? Backless stools have a smaller footprint than other seating choices and can slip under the table when not in use.



APPLICATIONS
High School

TEACHING METHOD

- Lecture

STUDENT BEHAVIOR

- Class

SPACE

- Rows

INFO-MEDIUM

- Mixed technology

Looking forward. Or elsewhere.

A central learning wall equipped with technology and whiteboards provides a focal point in lecture-oriented classrooms. Rows of tables enable students to turn around and face other students for spontaneous project work. Aisles between rows improve circulation. Tables can be easily moved into different configurations for presentations and discussions.

Mobile storage keeps frequently used materials close at hand and modular perimeter storage provides a convenient repository for everything else.



What our experience tells us

Is it just us, or are classrooms shrinking in new school designs? (Spoiler: They are.) Our response includes the new Illusions system that integrates media and analog storage around the perimeter of the room. Components range from 14" to 20" deep, saving up to 10 inches on every wall compared to traditional storage. Illusions also responds to a user desire to have storage and tables work together. That's right, having the tabletop and the storage shelf at exactly the same height didn't just happen by chance!



APPLICATIONS
Makerspace

TEACHING METHOD

- Facilitate

STUDENT BEHAVIORS

- Alone
- Group

SPACE

- Clusters

INFO-MEDIUM

- Mixed technology

Create, collaborate, communicate.

While no two makerspaces are the same, they all need to encourage students to explore creativity and critical thinking skills in a collaborative workspace. Our furniture provides spaces for hands-on activities and brainstorming while providing easy access to tools and bulk storage. Stools elevate students to eye level with teachers making the rounds to different stations, enhancing interaction.

We build flexibility into your makerspace so it can transform along with evolving student career objectives and community opportunities.



What our users tell us

We invited students at a Michigan high school to rethink the storage cabinet as part of their experience-driven curriculum. These sophomores learned how to apply an abstract design process to real-world problems, how to work as a team and build off each other's strengths, how to share their thinking outside the classroom and how to build something that's not just functional, attractive and environmentally sound, but also cost effective. Oh, and they came up with some cool ideas for materials, lighting, and technology that we just might adapt someday.



APPLICATIONS

Art

TEACHING METHOD

- Demonstrate

STUDENT BEHAVIOR

- Alone

SPACE

- Combination

INFO-MEDIUM

- Mixed technology

Setting the stage for inspiration.

Our furniture helps you enrich students' creative thinking skills through an environment that empowers hands-on problem-solving and communication skills. Rows of tables provide ample space for individual art generation while encouraging spontaneous collaboration with fellow students and circulating teachers. Stools allow unrestricted freedom of movement so students can approach projects from any perspective.

Generous perimeter storage offers a convenient access point for tools and materials while mobile storage doubles as a workspace for impromptu creative brainstorming.



What our research tells us

We tested our hypothesis that teachers and students would have higher-quality interactions if they looked each other in the eye.

Offering a higher table and stool helps bring everyone to the same level when teachers circulate through the room. Students do less slouching. Teachers do less bending and put less strain on their backs and hips. Stools also have a smaller footprint than the average classroom chair, making it easier to move through the aisles.



APPLICATIONS

Music

TEACHING METHOD

- Facilitate

STUDENT BEHAVIOR

- Group

SPACE

- Clusters

INFO-MEDIUM

- Low technology

Strike just the right note.

Create an attractive, inviting music room that showcases and provides easy access to instruments while providing abundant space for sheet music and uniforms. Our music storage solutions can be easily tailored to your unique needs, in colors and finishes that set just the right tone for your school. Chairs have flexing backs to allow a full range of movement while playing, and they can be moved quickly between ensemble and sectional practice.

Flip & Nest mobile tables can be moved in and out of active space for more traditional learning and chairs can be stacked and stored out of the way as needed.



What our experience tells us

When Fleetwood designed its first all-purpose chair, we took the time to do it right. We wanted to create something that fit our design language, quality standards and user needs.

The new Evoke™ chair provides every user with flexible, ergonomic comfort – whether they're leaning back during a presentation or sitting on the front edge of their seat waiting for the downbeat. And it stacks when it's time to clear the floor for the mixed chorus.

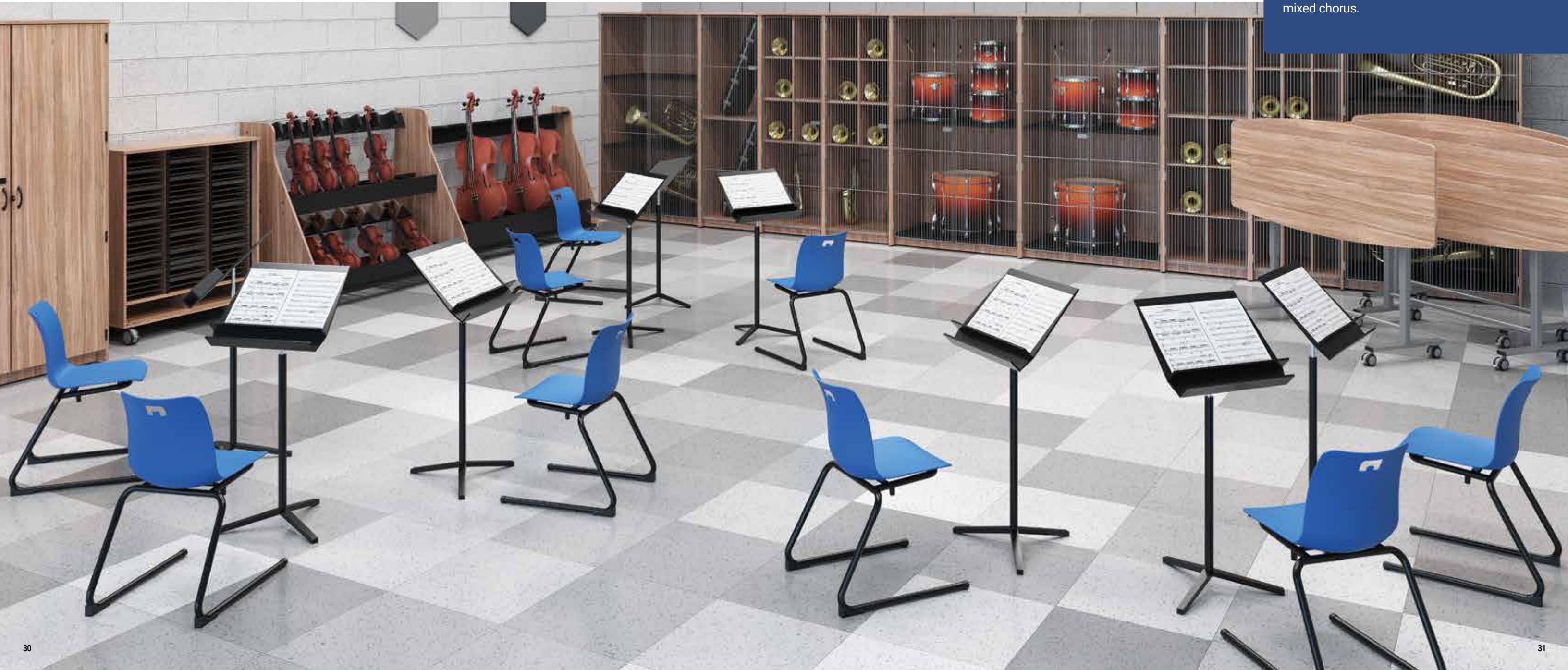

APPLICATIONS

Science

TEACHING METHOD

- Demonstrate

STUDENT BEHAVIOR

- Group

SPACE

- Clusters

INFO-MEDIUM

- Mixed technology

The right chemistry.

Our worksurface-equipped storage modules create a teaching demonstration area visible throughout the classroom. Presentation tools help teachers impart lessons in scientific theory and analysis. Large mobile tables give students the room to conduct experiments, collect data and collaborate in project teams. Reconfigurable storage around the perimeter of the classroom ensures easy access to material along with long-term flexibility and cost savings.

Everything from worksurfaces to stools is built tough enough to resist abuse from chemicals and students.



What our users tell us

We hear that some classroom chairs (not ours, of course) break within a few years of purchase. That's not surprising, since we've seen chairs used as ladders, raced in the hallways and otherwise abused. (While students show an amazing affinity for sitting on tabletops, our tables can handle it.) Fleetwood's durability promise and lifetime warranty eliminate headaches and support a total cost management strategy that mitigates risk and keeps students safe.



APPLICATIONS
STEM

TEACHING METHOD

- Demonstrate

STUDENT BEHAVIO

- Group

SPACE

- Clusters

INFO-MEDIUM

- High technology

Excellent technical support.

Studying math, physics and chemistry to investigate technical careers requires furniture that can support both lectures/demonstrations and project work. Our learning walls and whiteboards support the former, and our tables take care of the latter. Tables can be equipped with upper and lower storage for at-hand access to materials and supplemented with mobile tray storage.

Our mobile solutions help you create a dynamic, change-on-a-dime environment that mimics the way practicing engineers work today.



What our research tells us

How many times were we told in our youth to “sit still, for heaven’s sake.” It’s not easy. Our observations show that students shift postures hundreds of times throughout the day, and their furniture needs to support that. We should be encouraging movement, not punishing students for it. Another insight: If everyone’s using a motion-enabled stool, students with ADHD or other issues don’t stand out – they’re just part of the crowd.



APPLICATIONS

Career & Technical Education (CTE)

TEACHING METHOD

- Facilitate

STUDENT BEHAVIOR

- Alone

SPACE

- Combination

INFO-MEDIUM

- Mixed technology

Always up to the job.

Set students up for success by creating CTE spaces where they can develop in a variety of areas. Our furniture lets you design the classroom to transition between the academic and hands-on training needed for postsecondary and workplace advancement. Multiple types of workstations and storage components across the space provide plenty of room for diverse projects, objects and tools.

Sturdy, durable furniture is especially important in this demanding environment, and ours can take anything your teachers and students can dish out.



What our research tells us

Vertical spaces are at a premium in every classroom, and our Pages™ mobile markerboard system offers a collaboration tool wherever project teams gather. There are some subtle insights here: The aspect ratio of the boards is a pretty close match to most phone cameras, and the reinforced plastic corners protect the boards from damage if they get dropped. And, when you add up the cost of those paper flip charts, erasable markerboards pay for themselves in a hurry.



APPLICATIONS
Computer Lab

TEACHING METHODS

- Facilitate
- Personalize

STUDENT BEHAVIORS

- Alone
- Group

SPACE

- Combination

INFO-MEDIUM

- High technology

All systems go.

Our furniture accommodates individual, collaborative and social learning in a tech-rich environment that provides equitable access for all students. It also supplements classroom learning. Use fixed-height tables to maximize stability for computer equipment and adjustable-height tables to give students a respite from intense screen time. Vary seating models and heights to encourage bodies to move in all dimensions.

Utilize perimeter storage and presentation tools to give students an unrestricted view of teachers (and vice versa) and incorporate aisles for teachers to circulate through the space.



What our research tells us

First-generation school computer labs looked like the stereotyped image of a customer service call center (without the angry callers). They featured row after row of bulky computer terminals, with each person focused intently on their own screen and wearing headphones to block distractions. Now, in the next generation of computer labs, the machines are smaller and the collaboration is larger. We see a need to rethink these spaces to encourage mobility and teamwork.



APPLICATIONS

Library

TEACHING METHOD

- Personalize

STUDENT BEHAVIOR

- Alone

SPACE

- Combination

INFO-MEDIUM

- Mixed technology

Much more than a reading room.

You can use our furniture to create a vibrant, flexible library that goes beyond reading and independent research to support collaborative learning and creativity during and after school. Computer stations, whiteboards, and multiple seating and table types support both team and individual projects. Lower bookshelves help open up the space and provide staff visual access to students.

Biophilic colors and finishes work in harmony with plants and natural light to calm and center students.



What our experience tells us

Need a transaction desk? You'll find 23 variations on our website. Doors or no doors? Straight or curved? 48 inches or 84 inches wide? We account for as many possibilities as we can, but we also know that our customers may need a custom solution. There's a meeting every day on our factory floor to review special requests from an engineering, manufacturing and sales perspective. Or, our in-house sales advisors can often suggest a cost-effective alternative that doesn't require custom work.



APPLICATIONS
Media Center

TEACHING METHOD

- Personalize

STUDENT BEHAVIOR

- Group

SPACE

- Combination

INFO-MEDIUM

- Mixed technology

The mixed-media approach.

The techniques and technologies schools employ to aid teaching and learning are constantly evolving, so these spaces need to support yesterday's, today's and tomorrow's media. Our furniture supports the entire spectrum of instructional support and provides productive solutions to enhance student-centered reading, tech and learning skills development.

Mixing a variety of desks, tables and chairs helps establish specialized learning spaces and enhances future flexibility.



What our research tells us

Some of our insights are subtle, discovered through hours of user observation. Some of our insights are, well, obvious. Like this one: This is not your grandfather's school library. In fact, it might be called a media center now, and the collection goes way beyond books.

What will the media center look like another decade from today? We don't have the answer, but we've designed furniture and applications to be flexible, adaptable, durable and ready for whatever comes next.



APPLICATIONS
Commons

STUDENT BEHAVIORS

- Alone
- Group

SPACE

- Combination

INFO-MEDIUM

- Mixed technology

Make everyone feel welcome.

Nurture students' minds, bodies and spirits in a casual atmosphere that promotes community, equity, balance and enriched learning. Use our furniture to create multiple spaces that support different intentions – whether it's focusing on homework, working in groups, socializing with peers, or relaxing and recharging before tackling the next project.



What our users tell us

A commons area has many uses. It can be a place for students to work independently, for clubs to recruit new members or for parents to gather for an evening workshop. And if Dad sits in a chair designed for someone much smaller, or the dance team tries tapping on the tabletops or all the furniture gets shoved aside for a quick video shoot, don't worry. We've designed our products to stand up to intended and unintended use. And everything meets or exceeds industry standards for quality.



APPLICATIONS
Café/Life Center

STUDENT BEHAVIOR

- Group

SPACE

- Clusters

INFO-MEDIUM

- Low technology

Choice is on the menu.

You can use multiple Fleetwood table and chair combinations to comfortably accommodate individuals, small groups and large groups in this space, during and after school. Mobile Flip & Nest tables allow easy portability and storage while fixed standing-height options around the perimeter evoke restaurant ambience. Color-coded tables can aggregate student groups and cue janitors to combine smaller tables into larger table configurations for after-school meetings.

Tap into our extensive color palette to create a unique look and feel – bright and vibrant, warm and natural, polished or industrial. You can even incorporate your school colors.



What our users tell us

Kelli, a very real school cafeteria manager, writes, "I am looking for parts for an older cabinet in my school. It has held up very well and still has life left in it, but the rubber is wearing off the casters." Well, that's understandable, since as we verified the model number to make sure we provided the right replacement parts, we realized this cabinet was built sometime in the 1970s! (Got anything older? We'd love to hear about it.) Our furniture is built to last and is also designed in a way that makes it easy to swap in a new tabletop and give the space a fresh look.



APPLICATIONS

Teacher/Faculty Lounge

TEACHING METHOD

- Group

SPACE

- Combination

INFO-MEDIUM

- Low technology

A respite and retreat.

Make teachers' lounges work harder and smarter with our furniture. Provide discrete spaces to enjoy refreshments, relax individually, chat with peers and meet in large groups. Offer a range of secure storage of personal belongings. Set up work areas so teachers can prepare lessons before class. Equip the space with sharable tools, like tech walls, presentation carts and whiteboards, for easy access.

Teachers need to move their bodies every bit as much as students, so provide a variety of seating that promotes a wide range of motion.



What our research tells us

We know engagement leads to higher success rates in school, but engagement is not just a student issue. Teacher attrition was rising even before the pandemic – U.S. teachers leave their jobs at a higher rate than in most other countries – and post-COVID policies and protocols are adding to the pressure. How do we avoid burning out our teachers? Part of the answer comes by creating a classroom environment that energizes teachers and allows them to do their best work. Another part of the solution comes in creating a thoughtful sanctuary that teachers can call their own.



APPLICATIONS
Administration

TEACHING METHOD

- Personalize

STUDENT BEHAVIORS

- Alone

SPACE

- Combination

INFO-MEDIUM

- Mixed technology

Reinforcing your brand.

Your administrative offices should reflect the school's brand to the community. Create the image you want to project via thoughtfully chosen space layouts, furniture selection and color palettes. Our furniture also builds in functionality to support greeting and controlling visitors, meeting with students and parents, training staff and completing other school responsibilities.

Our timeless aesthetic complements any design and is compatible with any other furniture while our mobile solutions maximize flexibility.



What our research tells us

When we talk to administrators, we hear about classroom issues, but the conversation goes well beyond that. We hear the challenges of teacher and student retention, risk management and community support. Everyone wants to feel that money has been well spent.

Fleetwood products are designed to be a long-term investment that make an immediate visual impression, empower academic results and help tell the story of a shared commitment to learning.



Environments that keep flexing

The only constant in schools is change. Teaching methods evolve. Class sizes grow and contract. Technology races ahead. You need a furniture solution that can keep up the pace.

Fleetwood can. Our focus on flexibility – via mobility, height adjustability, universal compatibility and more – provides endless options for meeting your current demands (as the examples here demonstrate). We make it easy to transform spaces, whether it's during a class, between classes or over time. In fact, we virtually futureproof your classroom, empowering you to master whatever comes next.

For more inspiring ideas and space plans, visit our website: fleetwoodfurniture.com/thought-starters



> Thought Starters: High School



> Thought Starters: Third to Fourth Grade



> Thought Starters: Career & Technical Education





Tables & Desks

Versatile ▪ Robust ▪ Compatible

A wide variety of worksurface shapes and sizes, leg heights and accessories make our tables and desks adaptable (and re-adaptable) to virtually any school application. They're built to withstand decades of daily use and designed to complement all other Fleetwood products.

KEY FEATURES

- Fixed height and adjustable height leg options
- Heavy-duty levelers or locking casters
- 1" thick high-pressure laminate worksurfaces
- Pick-proof, moisture-resistant worksurface edges stand the test of time
- Smaller depth options support condensed footprints and wider aisleways



Tables & Desks that work together

The heights, widths and depths of all our tables and desks align easily to deliver a perfect fit. Color and finish options extend universally across the product selection to ensure a cohesive look. Rely on Fleetwood to maximize compatibility within and between school spaces, now and in the future.



Unitized Frame

You can depend on this rugged yet refined table to stand up to the most demanding classroom challenges, including science spaces. Height adjustability, mobility and technology options accommodate different users and purposes while enabling easy reconfiguration within or between rooms. Dent-resistant, welded steel frames impart exceptional strength and stability.



ELEVATE STUDENT ENGAGEMENT

Adjustable height Unitized Frame tables can be raised or lowered in 1" increments and are available with a chemical-resistant laminate surface – ideal for science labs.



WORKSURFACE OPTIONS

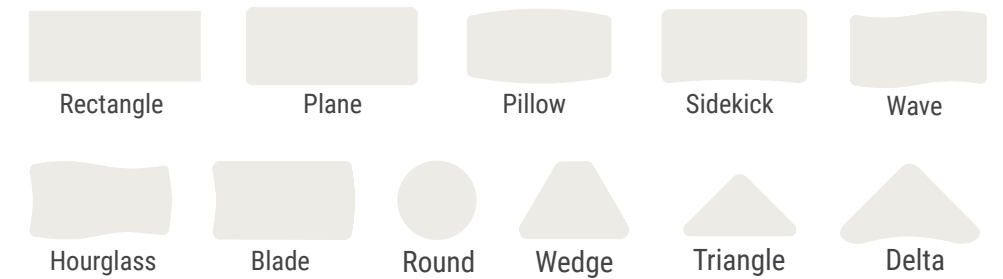

HEIGHT OPTIONS



SIZE OPTIONS

- Widths from 27" to 84"
- Depths from 20" to 48"

APPLICATION OPTIONS

- Kindergarten to Second Grade
- Third to Fourth Grade
- Fifth to Sixth Grade
- Junior High/Middle School
- High School
- Makerspace

MOBILITY OPTIONS

- Levelers
- Wheelbarrow
- Casters

- Art
- Music
- Science
- STEM
- Career & Technical Education (CTE)
- Computer Lab

TECHNOLOGY OPTIONS

- Grommets
- Wire management
- Power

- Library
- Media Center
- Commons
- Café/Life Center
- Teacher/Faculty Lounge
- Administration

C-Leg



Small desks maximize classroom space, but four-legged versions can be overly confining to seated students. Give your students more leg room and attention-enhancing comfort with this C-leg solution.

WORKSURFACE OPTIONS



HEIGHT OPTIONS



SIZE OPTIONS

- Widths from 27" to 54"
- Depth 20"

MOBILITY OPTIONS

- Levelers
- Casters

APPLICATION OPTIONS

- Kindergarten to Second Grade
- Third to Fourth Grade
- Fifth to Sixth Grade
- Junior High/Middle School
- High School
- Makerspace
- Science
- STEM

I-Leg



This alternative to traditional four-leg tables supports different aesthetic and functional needs while increasing knee swing area under the worksurface.

WORKSURFACE OPTIONS



HEIGHT OPTIONS



SIZE OPTIONS

- Widths from 40" to 72"
- Depths from 20" to 30"

APPLICATION OPTIONS

- Kindergarten to Second Grade
- Third to Fourth Grade
- Fifth to Sixth Grade
- Junior High/Middle School
- High School
- Makerspace



MOBILITY OPTIONS

- Levelers
- Casters

- Art
- Music
- Science
- STEM
- Career & Technical Education (CTE)
- Computer Lab

TECHNOLOGY OPTIONS

- Grommets
- Wire management
- Power

- Library
- Media Center
- Commons
- Café/Life Center
- Teacher/Faculty Lounge
- Administration



Flip & Nest

Give teachers the flexibility to move tables in and out of active use as needed. Press the recessed activation bar to flip worksurfaces up and roll them out of the way – or use them for vertical display.

WORKSURFACE OPTIONS

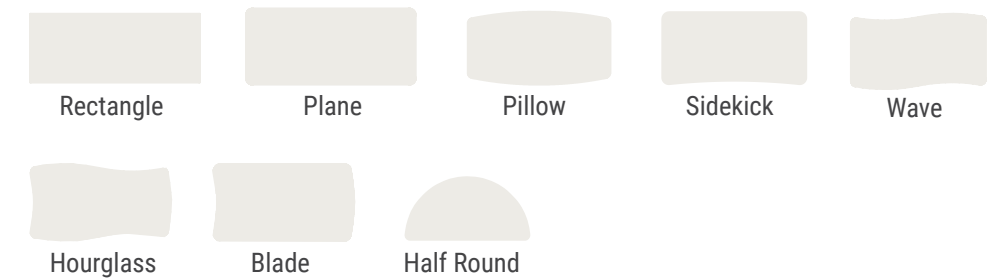

HEIGHT OPTIONS



SIZE OPTIONS

- Widths from 40" to 72"
- Depths from 20" to 30"

MOBILITY OPTIONS

- Casters

APPLICATION OPTIONS

- Kindergarten to Second Grade
- Third to Fourth Grade
- Fifth to Sixth Grade
- Junior High/Middle School
- High School
- Makerspace

- Art
- Music
- Science
- STEM
- Career & Technical Education (CTE)
- Library

- Media Center
- Commons
- Café/Life Center
- Teacher/Faculty Lounge



Post Leg

Integrate organic worksurface shapes, larger tops and unique configurations into your space. Fully welded legs are positioned to ensure strength, stability and comfort. Custom shapes available.

WORKSURFACE OPTIONS



HEIGHT OPTIONS



SIZE OPTIONS

- Widths from 36" to 72"
- Depths from 28.5" to 66"

MOBILITY OPTIONS

- Levelers
- Casters

APPLICATION OPTIONS

- Kindergarten to Second Grade
- Third to Fourth Grade
- Fifth to Sixth Grade
- Junior High/Middle School
- High School

- Makerspace
- Art
- Library
- Media Center
- Commons

- Café/Life Center
- Teacher/Faculty Lounge
- Administration





Single Pneumatic Base

Promote healthy movement by enabling teachers or students to alternate between sitting and standing heights throughout the day. An easy-to-operate handle underneath the worksurface adjusts height.

WORKSURFACE OPTIONS

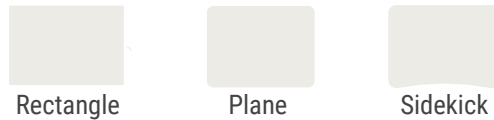

28-45"

HEIGHT OPTIONS

SIZE OPTIONS

- Width 30"
- Depth 24"

MOBILITY OPTIONS

- Casters

APPLICATION OPTIONS

- Kindergarten to Second Grade
- Third to Fourth Grade
- Fifth to Sixth Grade
- Junior High/Middle School
- High School
- Career and Technical Education (CTE)
- Library
- Media Center
- Commons
- Teacher/Faculty Lounge
- Administration



Double Pneumatic Base

Delivers height adjustability without electricity for total freedom of movement around a classroom. Allows quick changes between sitting and standing height in project-based learning environments. Supports a whopping 400 pounds at fixed height and 35 pounds when lifting or lowering.

WORKSURFACE OPTIONS



Levelers: 28-48"
Casters: 31-51"

HEIGHT OPTIONS

SIZE OPTIONS

- Width 30"
- Depth 60"

MOBILITY OPTIONS

- Levelers
- Casters

APPLICATION OPTIONS

- Kindergarten to Second Grade
- Third to Fourth Grade
- Fifth to Sixth Grade
- Junior High/Middle School
- High School
- Career and Technical Education (CTE)
- Library
- Media Center
- Commons
- Teacher/Faculty Lounge
- Administration



Stacker

Classrooms need tables but experiential learning also requires open areas. You can achieve both goals with these fully welded steel-leg tables, which stack up to three high.

WORKSURFACE OPTIONS

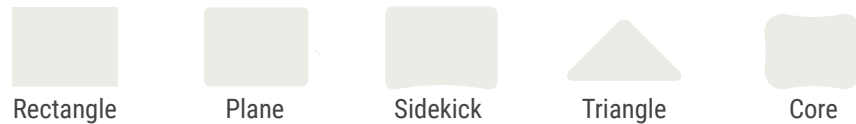

HEIGHT OPTIONS



SIZE OPTIONS

- Widths from 27" to 54"
- Depths from 22" to 27"

MOBILITY OPTIONS

- Levelers
- Wheelbarrow
- Casters

APPLICATION OPTIONS

- Kindergarten to Second Grade
- Third to Fourth Grade
- Fifth to Sixth Grade
- Junior High/Middle School
- High School
- Makerspace
- Science
- STEM



Picnic Table & Bench

Bring the outside in with this variation of an outdoor picnic table. The familiar vibe is meant to help students connect more informally in classrooms or common areas.

WORKSURFACE OPTIONS

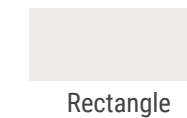

HEIGHT OPTIONS

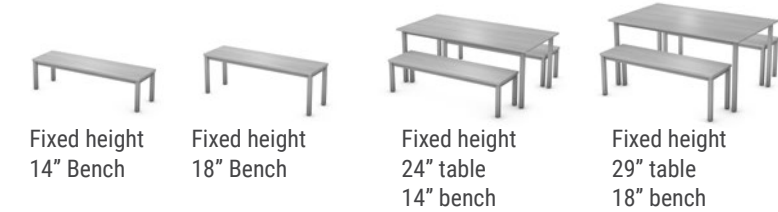

SIZE OPTIONS

- Table widths from 60" to 72"
- Table depths from 30" to 36"
- Bench widths from 51" to 63"
- Bench depth 15"

MOBILITY OPTIONS

- Levelers

APPLICATION OPTIONS

- Kindergarten to Second Grade
- Third to Fourth Grade
- Fifth to Sixth Grade
- Junior High/Middle School
- High School
- Makerspace
- Art
- Career and Technical Education (CTE)
- Library
- Media Center
- Commons
- Café/Life Center
- Teacher/Faculty Lounge
- Administration



Computer

Accommodate large digital displays and CPUs by routing cords through the rugged steel wire management box at the back of this table, which flips up for easy access.

WORKSURFACE OPTIONS



Flip Top

HEIGHT OPTIONS



Fixed height
29"

SIZE OPTIONS

- Widths from 36" to 72"
- Depths from 24" to 30"

MOBILITY OPTIONS

- Levelers
- Casters

TECHNOLOGY OPTIONS

- Flip top wire management, power

APPLICATION OPTIONS

- Fifth to Sixth Grade
- Junior High/Middle School
- High School
- Makerspace

- Art
- Career and Technical Education (CTE)
- Computer Lab
- Library

- Media Center
- Commons
- Administration



Crank Height Adjustable

Give students the power to gain new leverage or perspective on their projects through vertical table movement. Table legs and worksurfaces are engineered to support heavy weight.

WORKSURFACE OPTIONS



Rectangle

HEIGHT OPTIONS



Adjustable height
27"-38.5"

SIZE OPTIONS

- Width 60"
- Depth 42"

MOBILITY OPTIONS

- Levelers

TECHNOLOGY OPTIONS

- Grommets
- Flip top
- Wire management
- Power

APPLICATION OPTIONS

- Fifth to Sixth Grade
- Junior High/Middle School
- High School
- Makerspace
- Art

- Science
- STEM
- Career and Technical Education (CTE)
- Computer Lab
- Library

- Media Center
- Commons
- Administration



Pedestal Base

The pedestal base eliminates under-worksurface barriers to prevent knee knocks and support the organic gathering of students. The clean aesthetic declutters the visual landscape.

WORKSURFACE OPTIONS

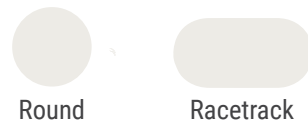

SIZE OPTIONS
 • Widths from 30" to 96"
 • Depths from 30" to 48"

MOBILITY OPTIONS
 • Glides

APPLICATION OPTIONS
 • Kindergarten to Second Grade
 • Third to Fourth Grade
 • Fifth to Sixth Grade
 • Junior High/Middle School

• High School
 • Library
 • Media Center
 • Commons

• Café/Life Center
 • Teacher/Faculty Lounge
 • Administration



Pedestal Base & Post Leg

D-shaped tops flush easily up to walls to provide space for team collaboration and the flat end is ideal for placing a digital monitor. Two tops can be quickly joined to double group sizes.

WORKSURFACE OPTIONS

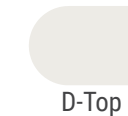

HEIGHT OPTIONS



SIZE OPTIONS
 • Widths from 42" to 48"
 • Depths from 60" to 72"

MOBILITY OPTIONS
 • Glides and Levelers

APPLICATION OPTIONS
 • Kindergarten to Second Grade
 • Third to Fourth Grade
 • Fifth to Sixth Grade
 • Junior High/Middle School
 • High School
 • Makerspace

• Art
 • Science
 • STEM
 • Career and Technical Education (CTE)
 • Computer Lab
 • Library

TECHNOLOGY OPTIONS
 • Grommets
 • Wire management
 • Power

• Media Center
 • Commons
 • Café/Life Center
 • Teacher/Faculty Lounge
 • Administration



Workstation

This standing-height, high-performance workstation provides plenty of easy-access storage, a range of durable worksurface material options and Fleetwood's trademark easy-rolling casters.

WORKSURFACE OPTIONS



Rectangle

HEIGHT OPTIONS



Fixed height
36"

36.75" (Maple block)

SIZE OPTIONS

- Widths from 60" to 66"
- Depths from 30" to 42"

MOBILITY OPTIONS

- Casters

APPLICATION OPTIONS

- Fifth to Sixth Grade
- Junior High/Middle School
- Makerspace
- Art
- Music
- Science
- STEM
- Career and Technical Education (CTE)
- Teacher/Faculty Lounge
- Administration





Full End Panel

Ideal for anchoring a space and conveying a sense of stability that attracts students. Large standing-height units invite gathering while narrower tops make great touchdown spots against walls or windows.

WORKSURFACE OPTIONS

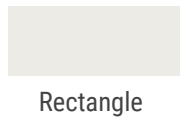

HEIGHT OPTIONS

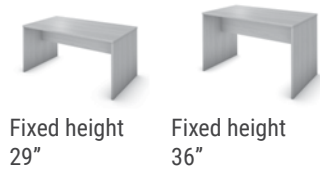

SIZE OPTIONS

- Widths from 60" to 84"
- Depths from 20" to 42"

MOBILITY OPTIONS

- Levelers

APPLICATION OPTIONS

- Fifth to Sixth Grade
- Junior High/Middle School
- High School
- Makerspace
- Art
- Career and Technical Education (CTE)
- Computer Lab
- Library
- Media Center
- Commons
- Café/Life Center
- Teacher/Faculty Lounge
- Administration



Wood Leg

The classic wood-frame science table is reinterpreted for a wider range of contemporary school environments. The warm aesthetic camouflages incredibly durable construction.

WORKSURFACE OPTIONS

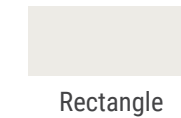

HEIGHT OPTIONS



SIZE OPTIONS

- Widths from 48" to 72"
- Depths from 24" to 42"

MOBILITY OPTIONS

- Levelers

APPLICATION OPTIONS

- Fifth to Sixth Grade
- Junior High/Middle School
- High School
- Makerspace
- Art
- Science
- STEM
- Career and Technical Education (CTE)
- Library
- Media Center



Conventional Desk

A traditional desking solution available in multiple configurations for different space and function requirements. Ample below-the-surface pedestal storage keeps the desktop clean for teachers, school staff, and students.

WORKSURFACE OPTIONS



HEIGHT OPTIONS



SIZE OPTIONS

- Widths from 48" to 66"
- Depths from 24" to 30"

MOBILITY OPTIONS

- Levelers (except D-Top)
- Casters

APPLICATION OPTIONS

- Kindergarten to Second Grade
- Third to Fourth Grade
- Fifth to Sixth Grade
- Junior High/Middle School
- High School

- Library
- Media Center
- Teacher/Faculty Lounge
- Administration



Carrel

High side and back panels maximize privacy for studying and test-taking, whether seated or standing. Equipped with grommets and wire management trays for routing cords and cables.

WORKSURFACE OPTIONS

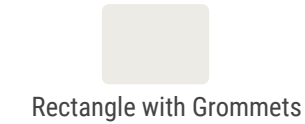

HEIGHT OPTIONS

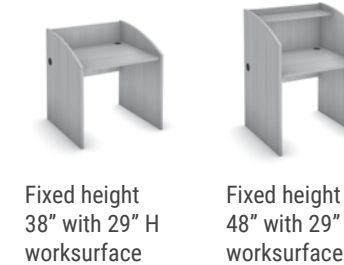

SIZE OPTIONS

- Width 36"
- Depth 30"

MOBILITY OPTIONS

- Glides

APPLICATION OPTIONS

- Fifth to Sixth Grade
- Junior High/Middle School
- High School
- Computer Lab
- Library
- Media Center

- Commons
- Teacher/Faculty Lounge
- Administration



Transaction Desk

This desk establishes a welcoming presence while reinforcing appropriate boundaries. Optional transaction counters and storage add functional space above and below the worksurface.

WORKSURFACE OPTIONS

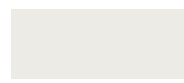

Rectangle



Radius Corner

HEIGHT OPTIONS



Desk Height
30"



Transaction Counter Height
10"
(Worksurface not included)



Under Worksurface Storage Height
26"

SIZE OPTIONS

- Case widths from 30" to 84"
- Case depth 30"
- Transaction counter widths from 24" to 48"
- Transaction counter depth is 10"
- Storage width 24"
- Storage depth 20"

MOBILITY OPTIONS

- Case base has levelers
- Under worksurface storage has casters

APPLICATION OPTIONS

- Library
- Media Center
- Commons
- Café/Life Center
- Administration

Other storage available; see Library Collection on pages 110-113

It's time to **raise** your game.



Accessories



BAG HOOK

Attaches anywhere to Unitized Frame and C-Leg desks and tables without protruding into aisle
Field or factory installed



UNDER WORKSURFACE SHELF

For 48", 54", 60" or 72" wide tables
Shelf with center support post provides extra storage within reach
Laminate shelf in Etched Gray laminate color
Factory installed

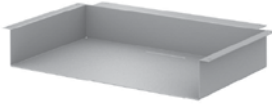

BOOK BOX-CLOSED

23" W x 4" H x 15" D
Use with worksurface size 30" wide to keep classrooms tidy
Field or factory installed



LOWER STORAGE SHELF

For tables with side rail, 48", 54", 60" or 72" wide
Laminate shelf in Etched Gray laminate color provides extra storage within reach
Factory installed

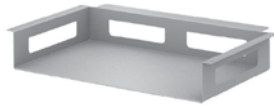

BOOK BOX-OPEN

23" W x 4" H x 15" D
Use with worksurface size 30" wide to let light in and keep students' material visible
Field or factory installed



BURELE POWER UNIT

4 power outlets
72" cord with circuit breaker plug
Color is Storm. Custom colors available
Field installed on tables. Factory installed on project carts

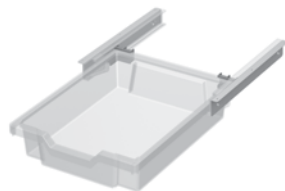

GRATNELLS TRAY AND RAILS

12.5" W x 3" H x 17" D
Use transferrable trays with worksurface size 30" wide
Rectangle or 27" wide Plane worksurface
Field or factory installed



BURELE POWER UNIT

2 power outlets, 1 HDMI and 2 USB
72" cord with plug
Color is Storm. Custom colors available
Field installed on tables



MODESTY PANEL

For 30", 48", 54" or 60" wide tables
Use with Unitized Frame desks and tables to provide modesty and indicate teachers' desks
Factory installed



MOIRE POWER UNIT

4 power outlets
72" cord with circuit breaker plug
Color is Storm. Custom colors available
Field installed on tables



SALT

USB, 72" cord
Color is Storm



Storage

Extensive ▪ Reliable ▪ Coordinated

Fulfill all your school storage needs in one place with a broad range of options offering endless flexibility, built-in mobility and rugged construction. Every product is visually and dimensionally compatible with each other and all other Fleetwood furniture.



Introducing Designer 2.0 & Illusions 2.0

Industry-leading mobility and durability meet unequaled choice and value in the next generation of our premier storage lines.

Now you have a single source to fulfill all your school storage needs – and all the products work in harmony with Fleetwood seating, tables and desks.

KEY NEW BENEFITS

- Comprehensive statement of line delivers customized solutions without the custom expense.
- Clean, crisp aesthetic lines.
- Alignment between/within units allows for mixing and matching of components.
- New products and sizes compress footprints and improve circulation and flow.
- Easy to use. Electronic planning tools and pre-assembled designs simplify specification and installation – it's virtually impossible to make a mistake.



Designer 2.0 on page 88

Illusions 2.0 on page 96

New, expanded finish palette on page 138





Designer 2.0

Clean • Versatile • Core

The clean, refined look of our Designer 2.0 series is timeless – a good thing, since the furniture is built to last a lifetime. Our one-of-a-kind casters make it easy to move and repurpose pieces, while ergonomic edges and anti-tipping mechanisms enhance safety. Abundant aesthetic and functional options – including particleboard, pegboard and magnetic markerboard backs – can be fine-tuned to fit any storage need and budget.



PROMOTE PARTICIPATION

Mobile storage can divide space and create teaming hubs for students. Laminate, markerboard and pegboard surfaces on storage backs provide interactive learning opportunities.



SHELF STORAGE



Shelf Storage - Straight - No Doors
 Access: 1 side, 2 side
 Width: 30", 36", 42", 48"
 Depth: 20"
 Height: 24", 29", 37", 44", 68"



Shelf Storage - Straight - Locking Doors
 Access: 1 side
 Width: 30", 36", 42", 48"
 Depth: 20"
 Height: 24", 29", 37", 44", 68"

CURVED STORAGE



Shelf Storage - Curved - No Doors
 Access: 1 side, 2 side
 Width: 60"
 Depth: 20"
 Height: 24", 29", 37", 44"



CUBBY STORAGE



Shelf - Cubby - No Doors
 Access: 1 side, 2 side
 Width: 36", 42", 48", 60"
 Depth: 20"
 Height: 24", 29", 37", 44", 68"

TRAY STORAGE



Tray Storage - No Doors
 Access: 1 side
 Width: 42"
 Depth: 20"
 Height: 24", 29", 37", 44"

Tray Storage - Locking Doors
 Access: 1 side
 Width: 48"
 Depth: 20"
 Height: 24", 29", 37", 44"



Tray-Shelf Storage - No Doors
 Access: 1 side
 Width: 42"
 Depth: 20"
 Height: 44", 68"

Tray-Shelf Storage - Locking Doors
 Access: 1 side
 Width: 48"
 Depth: 20"
 Height: 44", 68"



Markerboard - Tray Storage
 Access: 2 side
 Width: 36"
 Depth: 20"
 Height: 68"



FLOOR CUSHION STORAGE



Floor Cushion Storage - No Doors
 Access: 1 side
 Width: 32.5", 48"
 Depth: 20"
 Height: 24", 29", 37"

Floor Cushion - Shelf Storage - No Doors
 Access: 1 side
 Width: 32.5", 48"
 Depth: 20"
 Height: 44"

Markerboard - Floor Cushion Storage
 Access: 2 side
 Width: 36"
 Depth: 20"
 Height: 68"



MOBILE PEDESTAL STORAGE



Mobile Ped - Open/File Locking Drawer
 15" W x 28.75" H x 20" D

Mobile Ped - File/File Locking Drawers
 15" W x 28.75" H x 20" D

Mobile Ped - Box/Box/File Locking Drawers
 15" W x 28.75" H x 20" D



Mobile Ped - Trays
 No Door
 Holds up to 6 trays
 14.5" W x 28.75" H x 20" D



Mobile Ped - Box/File Locking Drawers
 15" W x 22.5" H x 20" D

DRAWER STORAGE



Drawer Storage
 Access: 1 side
 Width: 36"
 Depth: 27"
 Height: 29"



WARDROBE



Wardrobe Tower
Access: 1 side
Width: 24"
Depth: 20"
Height: 68"



Wardrobe - Shelf Storage
Access: 1 side
Width: 36"
Depth: 20"
Height: 68"



SHELF DRAWER



Shelf-Drawer Storage - Locking Doors
Access: 1 side
Width: 24", 30"
Depth: 20"
Height: 44", 68"



PROJECT CART



Project Cart - Locking Door
Access: 1 side
Width: 42"
Depth: 20"
Height: 29"



Project Cart - Locking Drawer & Door
Access: 1 side
Width: 42"
Depth: 20"
Height: 37"



3D PRINTER CART



3D Printer Cart
Access: 1 side
Width: 36"
Depth: 20"
Height: 37"



MONITOR HUTCH



Monitor Hutch - Low Hutch - Locking Doors
Access: 1 side
Width: 48"
Depth: 20"
Height: 68"



Monitor Hutch - Tall Hutch - Locking Doors
Access: 1 side
Width: 48"
Depth: 20"
Height: 68"

LOCKER



Lockers
Access: 1 side
Width: 48", 60"
Depth: 20"
Height: 44", 68"





Illusions 2.0

Architectural • Limitless • Futureproof

Get the look and feel of built-in storage solutions without the time and expense. Illusions 2.0 supports perimeter and space-division planning without locking you in – it's easy to move and reconfigure components as your needs change. Multiple sizes and configurations combined with modular flexibility give you near-endless options for personalizing your space.



WAY TO LEARN

Create attention-focusing learning walls that incorporate markerboards, digital technology and plenty of at-hand storage.

BASE SHELF STORAGE

Note: Tops sold separately



Base Shelf Storage - No Doors
 Access: 1 side
 Width: 15", 18", 24", 30", 36", 42", 48"
 Depth: 20"
 Height: 29", 37"



Base Shelf Storage - Locking Doors
 Access: 1 side
 Width: 15", 18", 24", 30", 36", 42", 48"
 Depth: 20"
 Height: 29", 37"

BASE SHELF DRAWER STORAGE

Note: Tops sold separately



Base Shelf - Drawer Storage - No Doors
 Access: 1 side
 Width: 15", 18", 24", 30", 36", 42", 48"
 Depth: 20"
 Height: 29", 37"



Base Shelf-Drawer Storage - Locking Doors
 Access: 1 side
 Width: 15", 18", 24", 30", 36", 42", 48"
 Depth: 20"
 Height: 29", 37"

BASE DISPLAY STORAGE

Note: Tops sold separately



Base Display Shelf Storage
 Access: 1 side
 Width: 36"
 Depth: 20"
 Height: 29", 37"

BASE TRAY STORAGE

Note: Tops sold separately



Base Tray Storage - No Doors
 Access: 1 side
 Width: 42"
 Depth: 20"
 Height: 29", 37"



Base Tray Storage - Locking Doors
 Access: 1 side
 Width: 48"
 Depth: 20"
 Height: 29", 37"

BASE DRAWER STORAGE

Note: Tops sold separately



Base Box Drawer Storage
 Access: 1 side
 Width: 15", 18", 24", 30", 36", 42", 48"
 Depth: 20"
 Height: 29", 37"



Base Box-File Drawer Storage
 Access: 1 side
 Width: 15", 18", 24", 30", 36", 42", 48"
 Depth: 20"
 Height: 29", 37"



Illusions 2.0, Designer 2.0 and tables are height, depth and width compatible.



Fillers are available to add depth or width to your Illusions 2.0 configuration.

Fillers are available to add depth or width to your Illusions 2.0 configuration.

BASE DRAWER SHELF STORAGE

Note: Tops sold separately



Base File Drawer Storage
Access: 1 side
Width: 15", 18", 24", 30", 36", 42", 48"
Depth: 20"
Height: 29", 37"



Base Box Drawer - Shelf Storage - Locking Door
Access: 1 side
Width: 30", 36", 42", 48"
Depth: 20"
Height: 29", 37"



Base Box-File Drawer - Shelf Storage - Locking Door
Access: 1 side
Width: 30", 36", 42", 48"
Depth: 20"
Height: 29", 37"

BASE SINK

Note: Tops sold separately



Base Sink - Locking Doors
Access: 1 side
Width: 36", 42", 48"
Depth: 20"
Height: 24", 29", 37"



Base Sink - ADA - No Doors
Access: 1 side
Width: 36", 42", 48"
Depth: 20"
Height: 29", 37"



BASE DESK

Note: Tops sold separately



Base Desk
Access: 1 side
Width: 30", 36", 42", 48"
Depth: 20", 24"
Height: 29", 33", 37"

WORKSURFACE BRIDGE



Worksurface Bridge
Access: 1 side
Width: 30", 36", 42", 48"
Depth: 20", 24", 25"
Height: 1"

BASE CORNER FILLER

Note: Tops sold separately



Base Corner Filler
Access: 1 side
Width: 24", 30"
Depth: 20", 24"
Height: 29", 37"

WORKSURFACE SPANNING



Worksurface Span
Access: 1 side
Width: 48"-120", 3" increments
Depth: 20", 24", 25"
Height: 1"

WORKSURFACE BACKSPLASH



Worksurface Backsplash
Access: 1 side
Width: 48"-120", 3" increments
Depth: 20", 24", 25"
Height: 4"



Fillers are available to add depth or width to your Illusions 2.0 configuration.

Fillers are available to add depth or width to your Illusions 2.0 configuration.

WALL HUNG STORAGE



Wall Hung Shelf - No Doors
 Access: 1 side
 Width: 15", 18", 24", 30", 36", 42", 48"
 Depth: 14"
 Height: 21", 29"



Wall Hung Shelf - Locking Doors
 Access: 1 side
 Width: 15", 18", 24", 30", 36", 42", 48"
 Depth: 14"
 Height: 21", 29"

WALL HUNG CORNER FILLER



Wall Hung Corner Filler - No Doors
 Access: 1 side
 Width: 18"
 Depth: 14"
 Height: 21", 29"

HUTCH STORAGE



Hutch-Shelf - No Doors
 Access: 1 side
 Width: 24", 30", 36", 42", 48"
 Depth: 14"
 Height: 39", 47"



Hutch-Shelf - Locking Doors
 Access: 1 side
 Width: 24", 30", 36", 42", 48"
 Depth: 14"
 Height: 39", 47"

MONITOR HUTCH STORAGE



Hutch-Monitor - No Doors
 Access: 1 side
 Width: 72", 84", 96"
 Depth: 14"
 Height: 39", 47"



Fillers are available to add depth or width to your Illusions 2.0 configuration.

TALL SHELF STORAGE



Tall Shelf Storage - No Doors
 Access: 1 side
 Width: 24", 30", 36", 42", 48"
 Depth: 20"
 Height: 68", 76", 84"



Tall Shelf Storage - Locking Doors
 Access: 1 side
 Width: 24", 30", 36", 42", 48"
 Depth: 20"
 Height: 68", 76", 84"

TALL CUBBY STORAGE



Tall Shelf Cubby - No Doors
 Access: 1 side
 Width: 24", 30", 36", 42", 48"
 Depth: 20"
 Height: 68", 76", 84"



TALL TRAY STORAGE



Tall Tray and Shelf Storage - No Doors
 Access: 1 side
 Width: 42"
 Depth: 20"
 Height: 68", 76", 84"



Tall Tray and Shelf Storage - Locking Doors
 Access: 1 side
 Width: 48"
 Depth: 20"
 Height: 68", 76", 84"



Fillers are available to add depth or width to your Illusions 2.0 configuration.

TALL SHELF-BOX DRAWER STORAGE



Tall Shelf-Box Drawer Storage
 Locking doors
 Access: 1 side
 Width: 24", 30"
 Depth: 20"
 Height: 68", 76", 84"

TALL WARDROBE STORAGE



Tall Wardrobe-Shelf Storage
 Locking doors
 Access: 1 side
 Width: 24", 30", 36"
 Depth: 20"
 Height: 68", 76", 84"

TALL LOCKER STORAGE



Tall Locker
 Access: 1 side
 Width: 36", 42", 48"
 Depth: 20"
 Height: 68", 76", 84"

Fillers are available to add depth or width to your Illusions 2.0 configuration.

BOOKCASE



Bookcase
 Access: 1 side
 Width: 24", 30", 36", 42", 48"
 Depth: 14"
 Height: 24", 29", 37", 44", 68", 76", 84"



Bookcase
 Access: 2 side
 Width: 24", 30", 36", 42", 48"
 NOTE: 28" W endcap bookcase (shown above right) for end-of-run applications
 Depth: 28"
 Height: 24", 29", 37", 44", 68", 76", 84"

HUTCH LEARNING WALL



Hutch-Shelf Learning Wall - No Doors
 Access: 1 side
 Width: 36", 42", 48"
 Depth: 20"
 Height: 39", 47"

MONITOR HUTCH LEARNING WALL



Monitor Hutch Learning - No Doors
 Access: 1 side
 Width: 72", 84", 96"
 Depth: 20"
 Height: 39", 47"

SLIDING BOARD LEARNING WALL



Sliding Board System-Learning Wall
 Access: 1 side
 Width: 72", 84", 96", 108", 126", 144", 168", 192"
 Depth: 6"
 Height: 39", 47"

Fillers are available to add depth or width to your Illusions 2.0 configuration.





Sheerline Collection

Strong • Smart • Stylish

Sheerline storage blends wood and steel for an urban, industrial look that complements any classroom design. Smooth steel perimeter frames and shelves stand up to the most demanding environments, including science spaces. Doors and drawers are engineered for superior utility and durability. Large, industrial casters make pieces easy to move yet incredibly stable.



SHELF



Shelf Storage - Straight - Single Sided
No Doors
48" W x 34.25" H x 22" D



Shelf Storage - Straight - Double Sided
No Doors
48" W x 34.25" H x 22" D



Shelf Storage - Straight - Single Sided
No Doors
48" W x 60" H x 22" D



Shelf Storage - Straight - Single Sided
No Doors
48" W x 72" H x 22" D



Shelf Storage - Straight - Single Sided
Locking Doors
48" W x 34.25" H x 22" D



Shelf Storage - Straight - Single Sided
Locking Doors
48" W x 60" H x 22" D



Shelf Storage - Straight - Single Sided
Locking Doors
48" W x 72" H x 22" D

TRAY & DRAWER



Tray Storage - Single Sided
No Doors
42.5" W x 44" H x 22" D



Drawer Storage - Single Sided
Non-Locking Drawers
5 Drawers
48" W x 34.25" H x 28" D

WARDROBE



Wardrobe Storage - Single Sided
Locking Doors
48" W x 72" H x 22" D



PRESENTATION CART



Shelf and Drawer Storage - Single Sided
Locking Doors and Drawers
Demonstration Mirror
60" W x 34.25" H x 24" D

PROJECT CART



Project Cart
Locking Door and Drawer
With and without power
Holds up to 12 trays
48" W x 34.25" H x 24" D



WORKSTATION



Workstation - Single Sided - Shelf
No Doors
60" W x 34.5" H x 24" D



Workstation - Double Sided - Shelf
No Doors
60" W x 34.5" H x 24" D

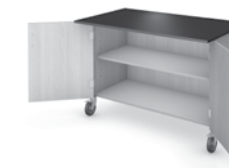

Workstation - Single Sided - Shelf
Locking Doors
50" W x 34.5" H x 30" D



Workstation - Single Sided - Shelf
Locking Doors
60" W x 34.5" H x 24" D



Workstation - Single Sided - Shelf
Locking Doors
60" W x 34.5" H x 30" D



Library Collection

Solid • Sharp • Studious

Not just for traditional libraries, this shelving, desks and mobile storage collection is also perfect for classrooms, media centers, common areas and administrative offices. It coordinates visually and functionally with other Fleetwood furniture – like study carrels page 79.



SHELF

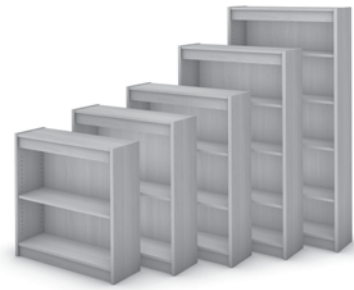

Shelf Storage - Straight - Single Sided - Stationary Starter:

- 36.5" W x 36" H x 12.625" D
- 36.5" W x 42" H x 12.625" D
- 36.5" W x 48" H x 12.625" D
- 36.5" W x 60" H x 12.625" D
- 36.5" W x 72" H x 12.625" D

Adder:

- 35.5" W x 36" H x 12.625" D
- 35.5" W x 42" H x 12.625" D
- 35.5" W x 48" H x 12.625" D
- 35.5" W x 60" H x 12.625" D
- 35.5" W x 72" H x 12.625" D



Shelf Storage - Straight - Double Sided - Stationary Starter:

- 36.5" W x 36" H x 24" D
- 36.5" W x 42" H x 24" D
- 36.5" W x 48" H x 24" D
- 36.5" W x 60" H x 24" D
- 36.5" W x 72" H x 24" D

Adder:

- 35.5" W x 36" H x 24" D
- 35.5" W x 42" H x 24" D
- 35.5" W x 48" H x 24" D
- 35.5" W x 60" H x 24" D
- 35.5" W x 72" H x 24" D



Shelf Storage - Straight - Double Sided - Mobile

- 36.5" W x 36" H x 24" D
- 36.5" W x 44" H x 24" D
- 36.5" W x 48" H x 24" D
- 36.5" W x 60" H x 24" D



TRANSACTION DESK

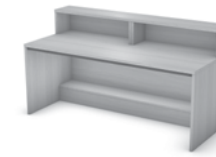

See more transaction desk offerings in Tables & Desks section. Call for desired configuration.



Desk Height 30"



Transaction Counter Height 10" (work surface not included)



Under Worksurface Storage Height 26"

BOOK BROWSER



Book Browser Storage - Double Sided - Mobile
4 Book Bins
8 Cubbys - Lower
30" W x 31" H x 30" D



Book Browser Storage - Double Sided - Mobile
6 Book Bins
6 Cubbys - Lower
41.5" W x 26" H x 29" D

BOOK TRUCK



Book Truck Storage - Double Sided - Mobile
36" W x 42" H x 18" D



FILLER



Shelf Storage - Filler - Corner
12.625" W x .75" H x 12.625" D



Shelf Storage - Filler - Inline
24" W x .75" H x 12.625" D



Harmony Music Storage

Inclusive • Secure • Attuned

Give aspiring musicians storage that's specially made for their craft. Tell us the quantity and types of instruments you want to accommodate, and we'll do the rest. Harmony also includes garment, printed music, folio, high-density and podium solutions, so you can equip your entire music room in style.

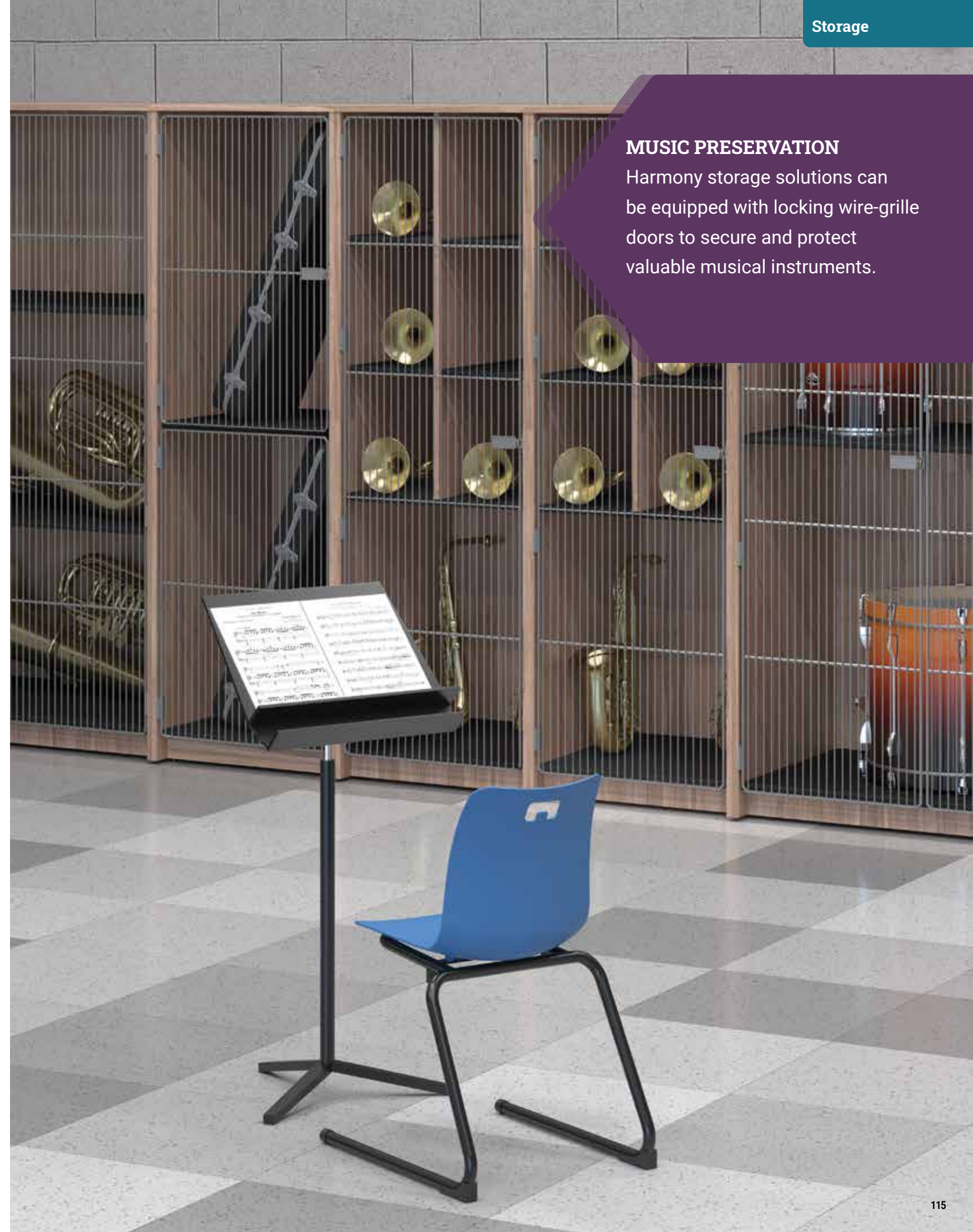

MUSIC PRESERVATION
Harmony storage solutions can be equipped with locking wire-grille doors to secure and protect valuable musical instruments.

FRONT OPTIONS

No Doors



Full Length Doors
Wire Grille



Compartment Doors
Wire Grille



Laminate Doors



INSTRUMENT CONT.



Instrument Storage - 10 Compartments
No Doors, Full Length Wire Grille Door,
Compartment Wire Grille Doors
27" W x 84" H x 30" D



Instrument Storage - 10 Compartments
No Doors, Full Length Wire Grille Door,
Compartment Wire Grille Doors
27" W x 84" H x 30" D
27" W x 84" H x 40" D



Instrument Storage - 15 Compartments
No Doors, Full Length Wire Grille Door,
Compartment Wire Grille Doors
27" W x 84" H x 20" D
27" W x 84" H x 30" D

INSTRUMENT

Shown in no-door version. See above for door options.



Instrument Storage - 1 Compartment
No Doors, Full Length Wire
Grille Door
27" W x 84" H x 30" D



Instrument Storage - 2 Compartments
No Doors, Full Length Wire Grille Door,
Compartment Wire Grille Doors
27" W x 84" H x 30" D
27" W x 84" H x 40" D



Instrument Storage - 2 Compartments
No Doors, Full Length Wire Grille Doors,
Compartment Wire Grille Doors
48" W x 84" H x 30" D



Instrument Storage - 3 Compartments
No Doors, Full Length Wire Grille Door,
Compartment Wire Grille Doors
27" W x 84" H x 30" D
27" W x 84" H x 40" D

GARMENT



Garment Storage - 1 Garment Rod,
3 Shelves
No Door, Full Length Laminate Door
27" W x 84" H x 30" D



Garment Storage - 1 Garment Rod,
3 Shelves
No Doors, Full Length Laminate Doors
48" W x 84" H x 30" D



Garment Storage - 2 Garment Rods
No Door, Full Length Laminate Door
27" W x 84" H x 30" D



Garment Storage - 2 Garment Rods
No Doors, Full Length Laminate Doors
48" W x 84" H x 30" D



Instrument Storage - 3 Compartment
No Doors, Full Length Wire Grille
Doors, Compartment Wire Grille Doors
48" W x 84" H x 30" D

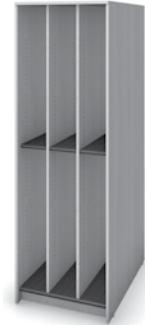

Instrument Storage - 6 Compartments
No Doors, Full Length Wire Grille Door,
Compartment Wire Grille Doors
27" W x 84" H x 40" D



Instrument Storage - 7 Compartments
No Doors, Full Length Wire Grille Door,
Compartment Wire Grille Doors
27" W x 84" H x 30" D
27" W x 84" H x 40" D



Instrument Storage - 9 Compartments
No Doors, Full Length Wire Grille Door,
Compartment Wire Grille Doors
27" W x 84" H x 30" D



Garment Storage - 1 Garment Rod,
1 Shelf
No Door, Full Length Laminate Door
27" W x 84" H x 30" D



Garment Storage - 1 Garment Rod,
1 Shelf
No Doors, Full Length Laminate Doors
48" W x 84" H x 30" D

FOLIO



Folio Storage
No Doors
2 Columns
29" W x 50" H x 18" D



Folio Storage
No Doors
3 Columns
42" W x 50" H x 18" D

STRINGS



Mobile Bass Storage
61" W x 60.5" H x 26" D



Mobile Cello Storage
75" W x 47" H x 22" D



Mobile Violin Storage
61.5" W x 53" H x 32" D

PODIUM



Podium
43" W x 48" H x 38" D



MUSIC



Music Storage System
16" W x 92" H x 44" D

FILLER



Filler - Corner
30" W x 84" H x 30" D
40" W x 84" H x 40" D



Filler - End
12" W x 84" H x 20" D
12" W x 84" H x 30" D
12" W x 84" H x 40" D



Filler - Top
27" W x .75" H x 10" D
27" W x .75" H x 20" D
48" W x .75" H x 10" D



Filler - Side
27" W x 84" H x 10" D
27" W x 84" H x 20" D
48" W x 84" H x 10" D



Seating

Comfortable • Energizing • Cool

Fleetwood seating collections are developed to comfortably support students while encouraging healthy movement that helps improve engagement and learning. Our chairs are made for a wide range of kids' bodies and all sorts of school settings, from the classroom to the cafeteria. They're also pretty cool – distinctive, colorful and oh-so-inviting.



Large shell
6th–12th

Medium shell
2nd–12th

Introducing Evoke

Simple • Apt • Livable

Based on a simple platform – a single, integrated back and seat in a solid shell with no ribs – Evoke is easy to use, easy to clean and easy to love. It can go almost everywhere, from the classroom to the cafeteria and back again. It's available in an eye-popping range of colors. And it provides comfortable, intuitive, ergonomic support that helps kids focus on learning.





Stacked and Packed

Evoke stacks up to 10 high, compared to 4-6 high for most school stackers, to allow more space-efficient storage. You can stack it on a table to ease floor cleaning. It's also packed with smart features, including molded-in metal connectors that will withstand years of abuse, rounded corners that prevent snags and built-in backpack hooks for easy access and improved flow-time between classes.



One chair for every body.

Three shell sizes accommodate all age groups and body types. Multiple base options adapt to any environment and task. Every version has a flexing back for automatic comfort and support.



Small shell
Pre-K-2nd



STACKER

Stack up to 10 high to maximize storage density.

Seat Heights: 10", 12", 14", 16", 18"



REVERSE CANTILEVER

Stack up to 6 high; place atop tables for easy floor cleaning.

Seat Heights: 14", 16", 18"



CASTER

Not only does this mobile chair support agile classrooms, but it also stacks.

Seat Height: 18"



TASK

Easy mobility and height adjustability for teachers and older students.

Seat Height Range: 16"-21"



TASK STOOL

Supports sit and stand postures while providing mobility and height adjustability.

Seat Height Range: 22"-32"



STOOL

Ideal for alternating sit and stand postures.

Seat Heights: 26", 30"



Heights: 18", 22", 26"
Seat width: 13.5"
rounded square
Oversized glides

Rock

Stimulating • Comfy • Sturdy

Rock™ active stools elevate learning by promoting body movement and student engagement. The unique seat design encourages the kind of motion that turns tired, distracted students into active learners. Sturdy backless design, age-appropriate height options and gentle seat contours improve blood circulation, posture, attentiveness and eye-to-eye interaction.



More Room to Learn

ON THE MOVE

Most students can't sit still – nor should they. Rock enables kids to change posture more frequently, in natural, healthy ways that don't disrupt classroom learning.



SIT

Allowing students to easily alternate between sitting, standing and perching enhances their well-being.



PRODUCTIVE FIDGETING

Our patent-pending seat mechanism supports non-disruptive, front-to-back and lateral pivoting action for better attentiveness.



STAND

Alternating posture between sitting and standing is proven to provide positive health benefits.



ROTATE

The non-handed, backless seat allows students to easily swivel as class focal points change.



PERCH

Rock's stable base provides a safe, non-disruptive solution for perching.



EYE-TO-EYE

Elevating students brings them eye-to-eye with teachers for improved interactions.

ROCK PROVIDES MORE SEATED CIRCULATION SPACE THAN SEAT WITH BACK

Gain 6" in aisleway between rows with Rock so rooms feel less congested.

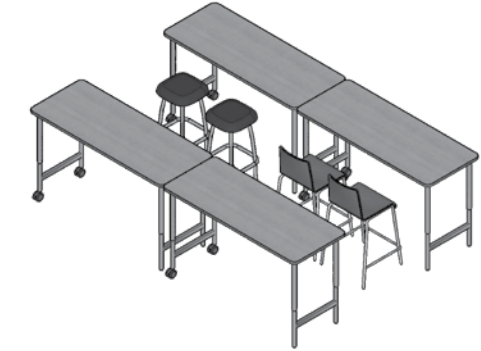
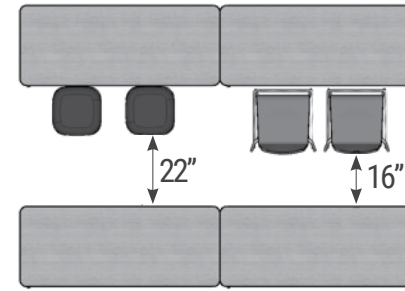

ROCK OPENS UP MORE STANDING CIRCULATION SPACE THAN SEAT WITH BACK

Gain 21" in aisleway between rows when students stand because Rock easily tucks under tables. Teachers can freely move between project teams to facilitate learning.

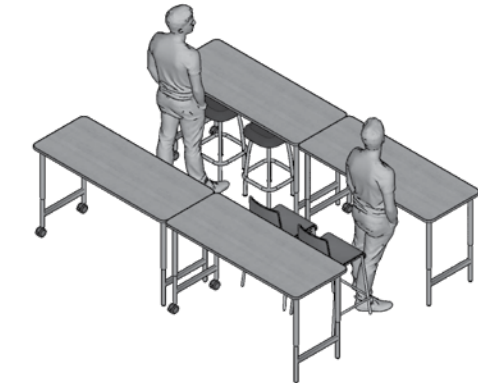
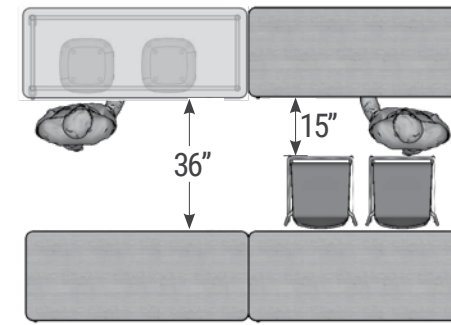

ROCK SUPPORTS COMPRESSED CLASSROOM FOOTPRINTS BETTER THAN SEAT WITH BACK

Rock's smaller scale allows tables to shrink, which opens up floorplans.

Desk with seats with back

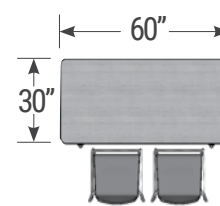

Desk with Rock stools

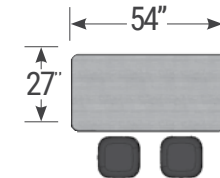

Row-based application

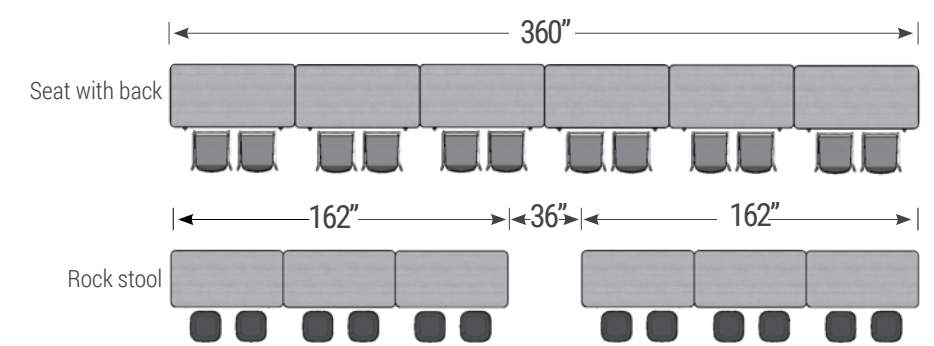

Cluster-based application

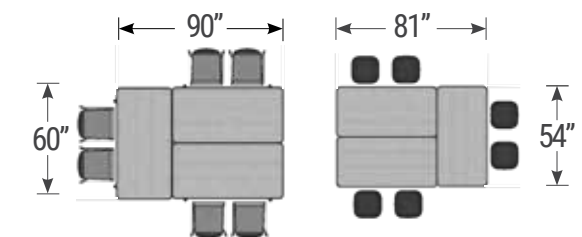



Soft Rock

Cushy • Lively • Cheerful

Like the Rock stool, this fully upholstered seating solution is designed to encourage students to move in ways that naturally focus attention and engagement. It can be equipped with a special base that allows an even wider range of motion. Soft Rock is available in multiple heights to suit different body sizes and create a varied visual landscape.

Stool heights: 12", 14", 16", 18"
 Seat width: 15"
 Styles: Fixed base or active base
 Floor cushion height: 3"



FIDGET FRIENDLY

Choose a fixed base or patent-pending active-base seat mechanism that allows even more movement and productive fidgeting.



SMART DESIGN

Detail stitching, stain-resistant fabric and dual-density foam optimize aesthetics, cleanability, comfort and stability.



EASY MOBILITY

Even the smallest students can pick up and move these lightweight floor cushions.

Height	Grade
3"	K-4
12"	K-1
14"	1-2
16"	2-5
18"	5-12

MULTIPLE HEIGHTS

Pick the right height for your growing students and their activities.





Available 14" high
and 18" high

Bench

Sturdy, welded-frame bench complements our picnic table (page 69) and adds alternate seating solutions to classrooms, commons, hallways and administrative waiting areas.



> All the right **moves**
for better learning.



Accessories

Easy • Economical • Efficient

Fleetwood rounds out its school furniture offering with easy-to-use presentation tools for sharing and collaborating, whether in front of a classroom or a school board. Their long service life makes them more cost-effective and environmentally friendly than paper-based solutions, and – like all Fleetwood products – they’re built to move.



Pages Dry Erase Marker Board System

Stackable • Movable • Sociable

Take collaboration to a new level with lightweight, stackable whiteboards that work individually or mount in multiples to mobile carts, cabinets and walls (either horizontally or vertically). Boards are made of durable, high-pressure laminate and have magnetized corners and brackets that easily click together and pop apart.



VERTICAL CARTS

Pages Vertical Cart with casters and 4 panels
23.5" W x 60" H x 22" D
23.5" W x 72" H x 22" D



HORIZONTAL CART

Pages Horizontal Cart with casters and 4 panels
42" W x 72" H x 22" D



REPLACEMENT KIT

Pages Replacement Panels Kit
4 panels
23.5" W x 42" H x .5" D



DRYWALL MOUNT KIT

4 panels
23.5" W x 42" H x .5" D
Includes template for peg wall placement. Pegs also sold separately.
Graphite only



LAMINATE STORAGE MOUNT

Laminate Tall Storage Mount Kit with 4 panels
23.5" W x 42" H x .5" D
Includes template for placement
Graphite only

PAGES SYSTEM

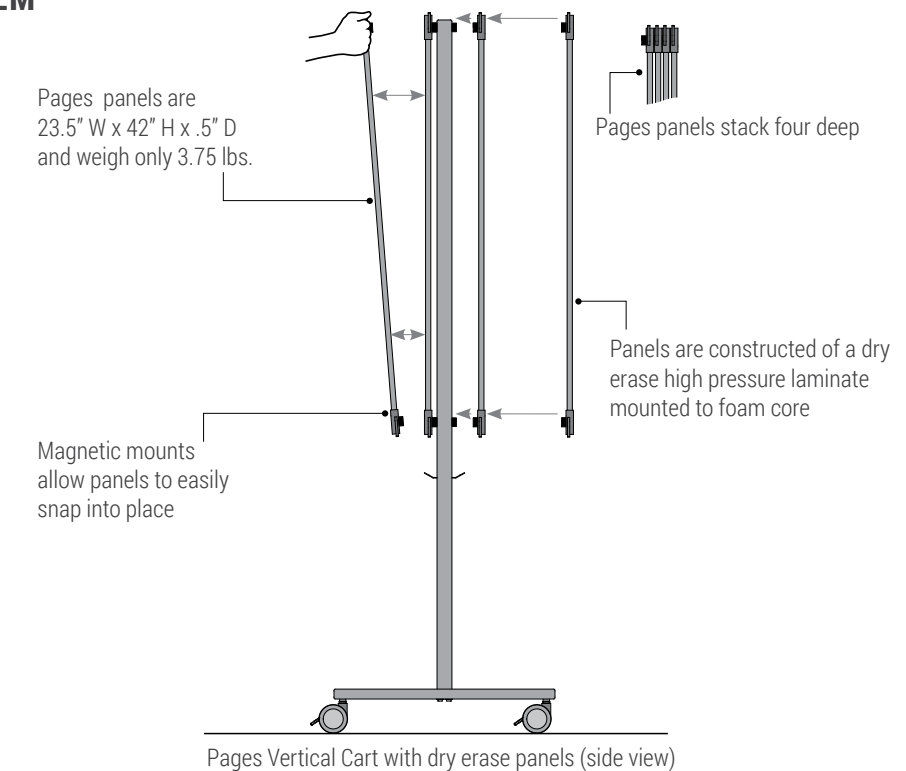



Finishes

Inspiring ▪ Biophilic ▪ Unifying

We've expanded our color palette to incorporate more hues inspired by nature, which are proven to help improve learning outcomes. Most laminates are from Wilsonart's open line, making it easy to match existing product from other sources. We also have access to all major laminate suppliers' offerings.

Laminate Options

Contemporary Laminates



White



Gray



Wrought Iron



Black



Aqua Lagoon



Cafe Sienna



Island



Summer Vacation

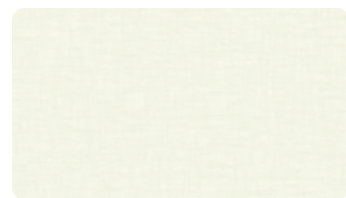

Magnolia **NEW**



Mushroom **NEW**

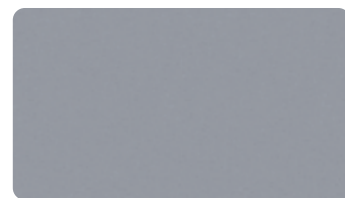

Battleship **NEW**



Blackbird **NEW**



Sunny Side Up **NEW**



Dragon Fire **NEW**



Candy Apple **NEW**



Robin **NEW**



Cornflower **NEW**



Moroccan **NEW**



Fresh Cut **NEW**



Nori **NEW**



Catalina **NEW**



Concord Grape **NEW**



Taupe **NEW**



Greige **NEW**

Additional laminate and edgeband options as well as epoxy resin worksurfaces are available as special order.

This brochure contains printed representations of laminate, edge, and paint colors. Colors may differ from actual product; please refer to actual samples before ordering.



Sunbeam



Catching Fireflies **NEW**



Macchiato **NEW**



Rugged Trail **NEW**



Planetree Maple **NEW**



Natural Rift **NEW**



Santa Rosa Plum Tree **NEW**



A Good Book **NEW**

Classic Laminates



Cavalcade South



Etched Gray



Grey Matrix



Charcoal Matrix



Fusion Maple



Light Oak



Honey Maple



Oiled Cherry



Trytoo Savatre

Specialty worksurface options

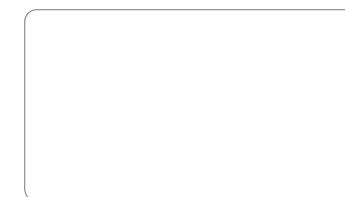

White Markerboard
We recommend using an edgeband color that matches the frame color.

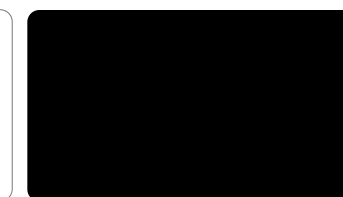

Black Chemical Resistant HPL

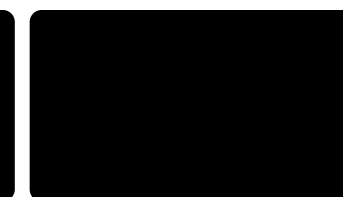

Black Chemical Resistant Phenolic Resin



Solid Maple Block Resin

Edgeband Options

Matched Edgebands for Contemporary Laminates

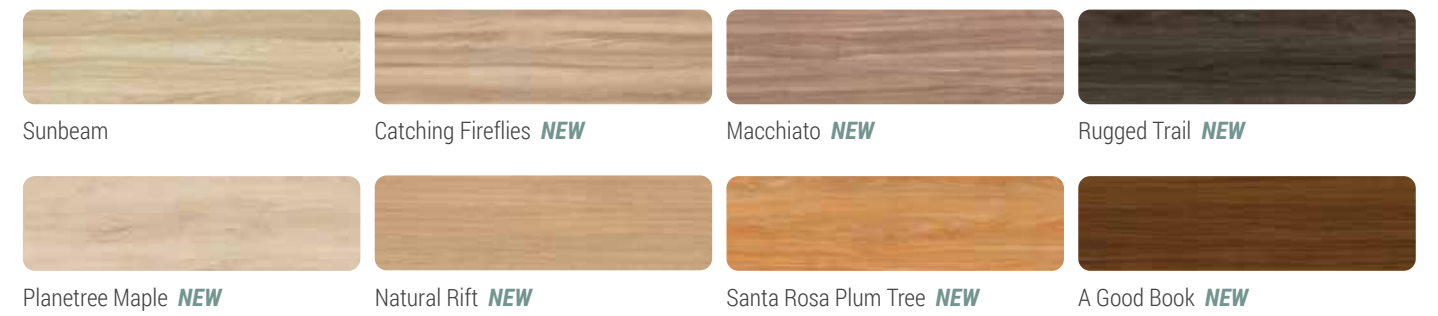

Matched Edgebands for Classic Laminates

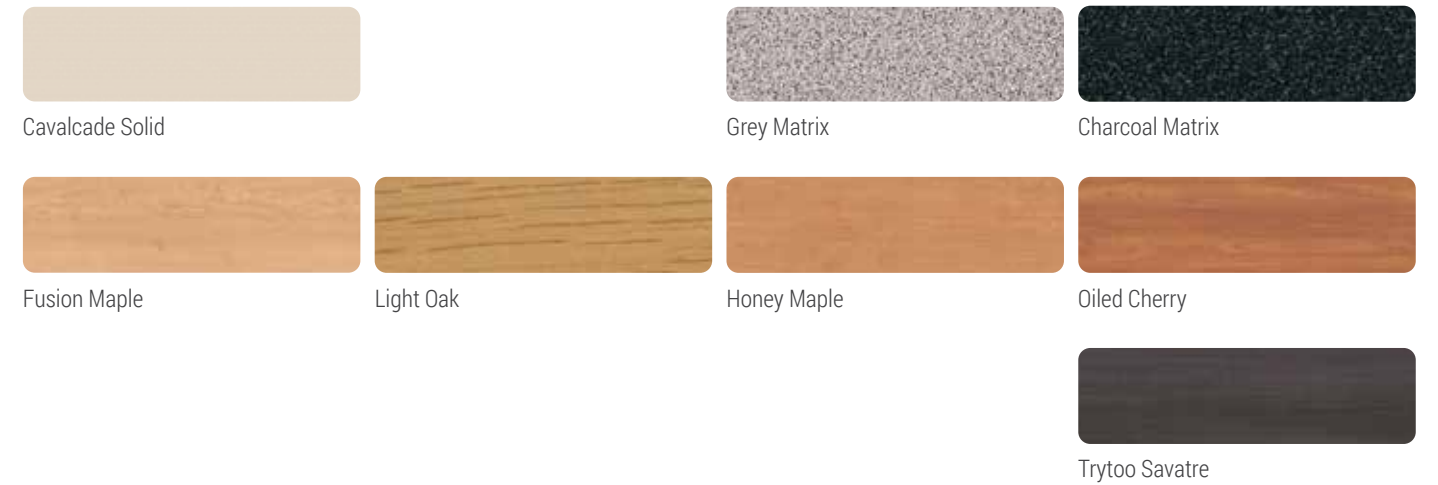

Accent Edgeband



Paint Matched Edgebands

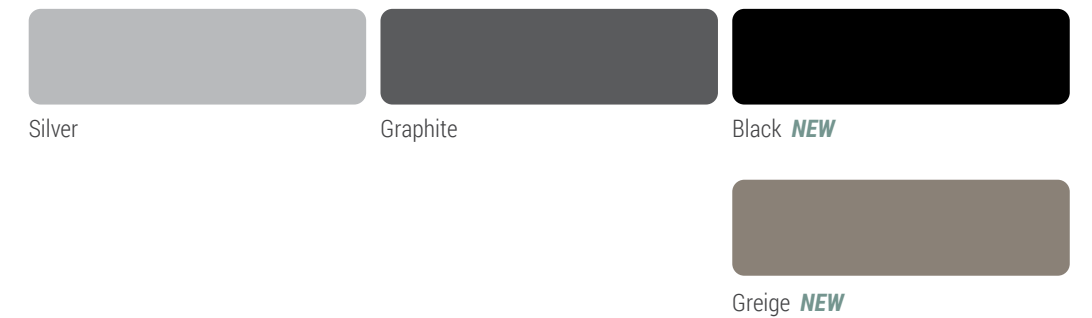

Additional laminate and edgeband options as well as epoxy resin worksurfaces are available as special order.

This brochure contains printed representations of laminate, edge, and paint colors. Colors may differ from actual product; please refer to actual samples before ordering.

Paint Options

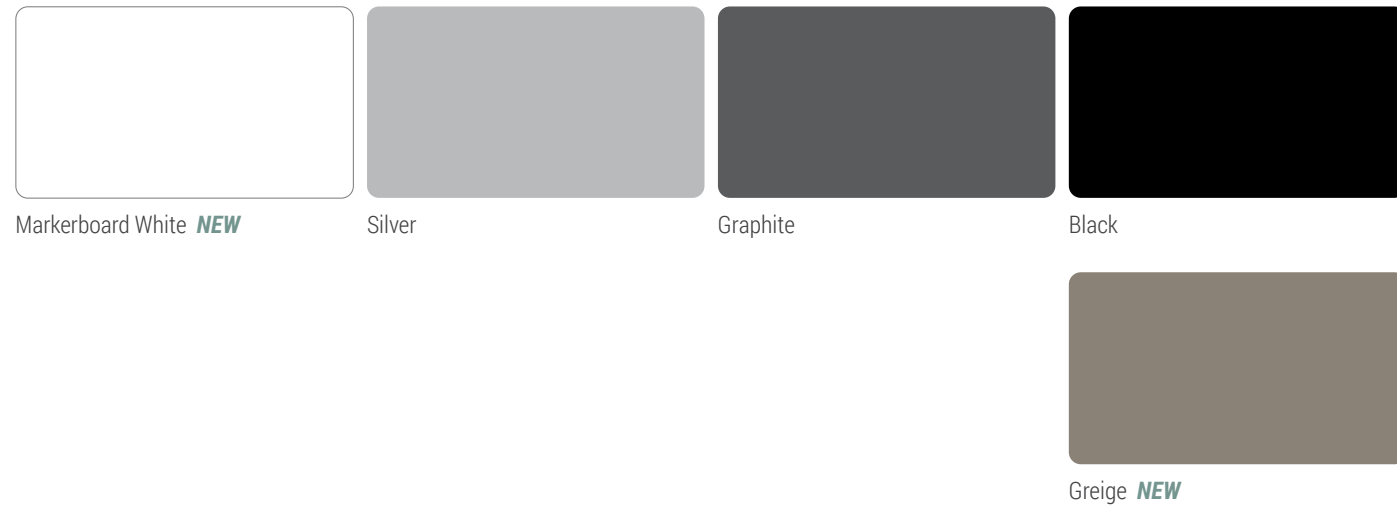

Invoke Chair Shell Color Options



This brochure contains printed representations of laminate, edge, and paint colors. Colors may differ from actual product; please refer to actual samples before ordering.

Fabric Options

Bold, bright, biophilic Silvertext[®] fabrics for our Soft Rock seating line expand aesthetic possibilities and beautifully withstand years of daily use.



EMPLOYEES MATTER

We think our furniture sets us apart. We KNOW our people set us apart. Fleetwood is the only ESOP (employee stock ownership program) company in our industry, which means the people designing, building and delivering your furniture are the owners of the company. And we see time and time again how that impacts their willingness to go the extra mile and make sure things are done right the first time.

Giving Back to the community

Fleetwood has a long history of giving back. A significant portion of its profits go to missions – around the world and just down the street from our factory and offices in West Michigan. Plus, Fleetwood's employee owners donate time to make a difference at nonprofits.

We recently helped the Holland Rescue Mission refresh its daycare center. There's no better reward than seeing the smiles on the faces of our youngest users.





For help creating your effective learning environment,
contact us at 616.396.1142 or sales@fleetwoodfurniture.com.

