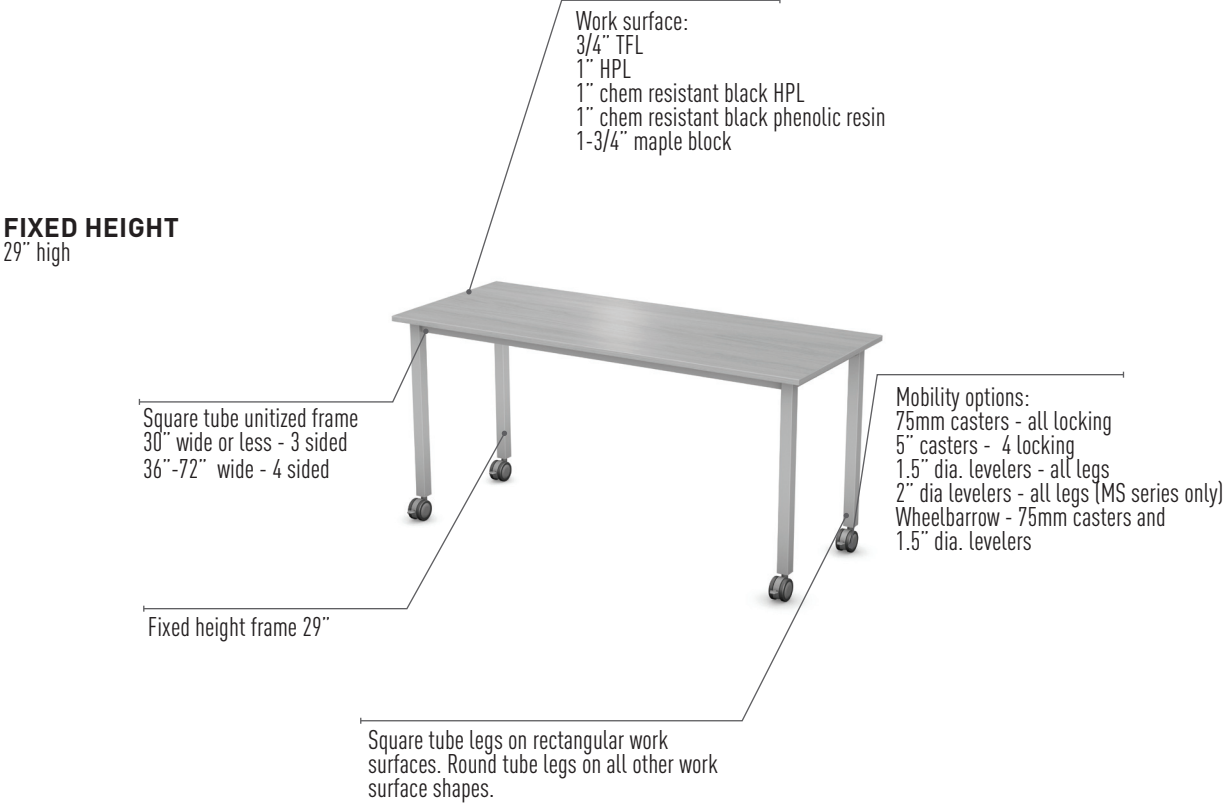

TABLE & DESK - UNITIZED FRAME

This table features a fully welded steel frame under the work surface perimeter that is connected to round or square legs. It stands up to a lifetime of classroom abuse.



SHIPPING

- Work surfaces ship separate from frames
- Frames ship stacked
- Levelers or caster stems installed on legs
- Casters field installed
- Product weights shown exclude packaging materials

PRODUCT DETAILS



75mm locking casters

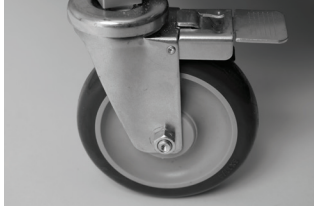

5" casters



1.5" dia. Levelers



2" dia. Levelers



Frame underside



Leg adjustments

TABLE & DESK - UNITIZED FRAME

ADJUSTABLE HEIGHT

20-28" high
24-32" high



ADJUSTABLE HEIGHT H-FRAME

29-42" high



ADJUSTABLE HEIGHT H-FRAME WITH FOOT RAIL

29-42" high
(with 36", 42", or 48" deep work surface)
34-42" high

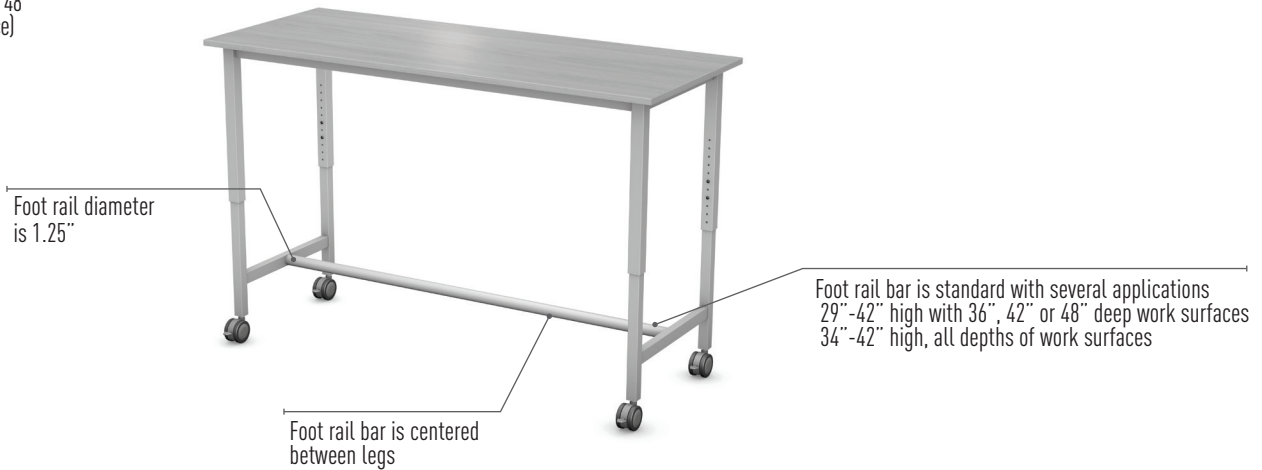

TABLE & DESK - UNITIZED FRAME

UNITIZED FRAME TABLE & DESK WORK SURFACE SHAPES











		Work Surface Dimensions										
Page	Table Leg Style	Depth	Width									
			27"	30"	36"	41"	42"	48"	54"	60"	72"	84"
 Rectangle	Square	20"	•	•				•	•	•	•	
	Square	24"	•	•	•			•	•	•	•	
	Square	27"							•			
	Square	30"		•	•			•	•	•	•	
	Square	36"			•			•	•	•	•	
	Square	42"					•			•	•	•
	Square	48"						•				•
 Plane	Round	20"	•	•				•	•	•	•	
	Round	24"	•	•	•			•	•	•	•	
	Round	27"							•			
	Round	30"		•	•			•	•	•	•	
	Round	36"			•			•	•	•	•	
	Round	42"					•					
	Round	48"						•				
 Pillow	Round	20/24"	•	•	•							
	Round	24/28"						•				
	Round	24/29"							•			
	Round	27/29"							•			
	Round	24/30"								•	•	
 Sidekick	Round	24"	•	•	•			•	•	•	•	
	Round	27"							•			
 Blade	Round	30"								•		
 Hourglass	Round	30"								•		
 Wave	Round	30"								•		
 Round	Round	42"					•					
 Delta	Round	25"				•						
 Triangle	Round	22"				•						
 Wedge	Round	24"		•								

TABLE & DESK - UNITIZED FRAME

UNITIZED FRAME WORK SURFACE SHAPE INNER AND OUTER DIMENSIONS

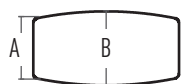

Pillow

Nominal		Actual	
W	D	A	B
27"	20"/24"	20"	24"
30"	20"/24"	20"	24"
36"	20"/24"	20"	24"
48"	24"/28"	24"	28"
54"	24"/29"	24"	29"
54"	27"/29"	27"	29"
60"	24"/30"	24"	30"
72"	24"/30"	24"	30"



Sidekick

W	D	A	B
MOST*	24"	22.6"	24"
54"	27"	25.6"	27"

* Excludes 54"



Hourglass

W	D	A	B
60"	30"	30"	26.375"



Wave

W	D	A	B
60"	30"	30"	28.16"

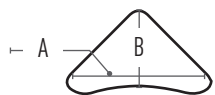

Delta

W	D	A	B
41"	25"	39.8"	21.01"



Triangle

W	D	A	B
41"	22"	40.77"	21.97"

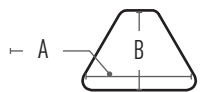

Wedge

W	D	A	B
30"	24"	30"	23"

SPACE BETWEEN LEGS

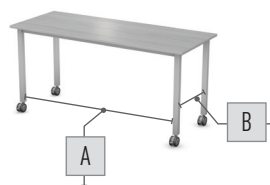

Work Surface		Distance Between	
W	D	A	B
30"	20"	23.25"	16.25"
42"	24"	35.25"	17.25"
48"	27"	41.25"	20.25"
54"	30"	47.25"	23.25"
60"	36"	53.25"	29.25"
72"	42"	65.25"	35.25"
84"	48"	77.25"	35.25"

MOBILITY OPTION EXAMPLES



Levelers



Wheelbarrow



Casters

TABLE & DESK - UNITIZED FRAME
TABLE CONFIGURATION IDEAS

RECTANGLE & PLANE



BLADE



HOURGLASS



WAVE



ROUND & HALF ROUND



DELTA



TRIANGLE



WEDGE

